



Soil oxygen measurement system

Operating instructions (Quick guide)



Meet the difference

Contents

About this manual.....	3
1. Soil oxygen measurement system	3
1.1 Composition of the set	3
1.2 Installing the batteries in the GX-8000 meter	4
1.3 Attaching the oxygen probe and gas sampling hose to the GX8000	4
1.4 LCD Display	6
2. Starting and stopping the meter.....	7
3. Recording the measurements manually.....	7
4. Screen reading options.....	7
5. Checking the soil oxygen meter set	8
5.1. Calibration of the meter	8
5.1.1 Fresh air calibration	9
6. Use of the soil probe with the GX-8000 oxygen meter	10
7. Maintenance of the soil probe	10
7.1 Air pressure	11
7.2 Temperature	11
8. Specifications.....	11

Nothing in this publication may be reproduced and/or made public by means of print, photocopy, microfilm or any other means without previous written permission from Royal Eijkelkamp. Technical data can be amended without prior notification.

Royal Eijkelkamp is not responsible for (personal) damage due to (improper) use of the product.

Royal Eijkelkamp is interested in your reactions and remarks about its products and operating instructions.

About this manual



If the text follows a mark (as shown on the left), this means that an important instruction follows.



If the text follows a mark (as shown on the left), this means that an important warning follows relating to danger to the user or damage to the apparatus. The user is always responsible for its own personal protection.

Text

Italic indicated text indicates that the text concerned appears in writing on the display (or must be typed).



This document provides only the most important information and instructions on working with the soil oxygen probe together with the GX-8000 oxygen meter. In addition, the user must also consult the contents of the detailed manual. Your meter, the GX8000, is only equipped with an oxygen sensor.

1. Soil oxygen measurement system

1.1 Composition of the set

The set consists of a soil air probe (probe cone with handle and silicone hose, art. nr.: 143501), a digital soil oxygen system type GX-8000 (art. nr.: 143515) with a gas sampling hose and a probe (see Figure 1). The accessories of the GX-8000 meter consist of:

- A charger or 3 AA alkaline batteries 1.5V
- Shoulder strap
- Detailed manual of the GX-8000 meter



Fig. 1 Soil oxygen measurement system

1.2 Installing the batteries in the GX-8000 meter

The batteries (3 pieces 1.5V AA type) are installed in the battery compartment at the bottom side of the meter. This compartment can be opened by turning the screw (1) in the lid to the left with a screwdriver. When inserting the batteries, make sure that the polarity of the batteries is correct (see markings in the meter) and that the lid (2) is properly closed afterwards.

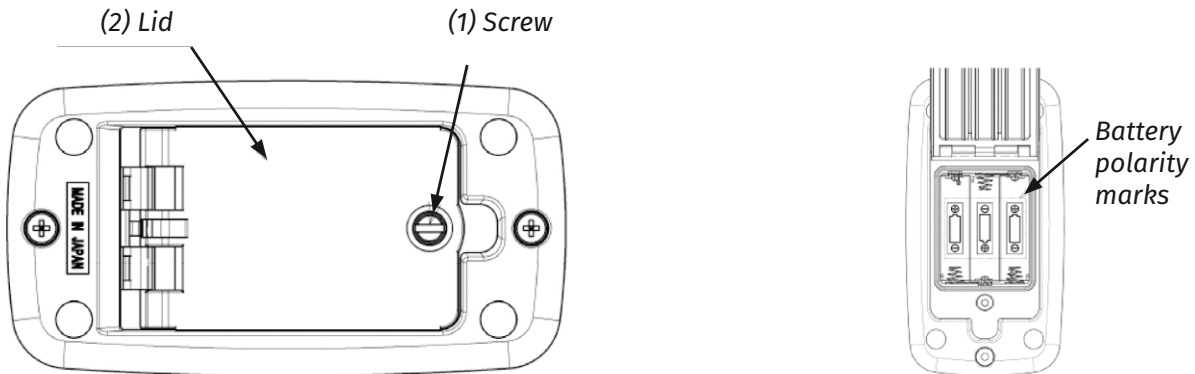

Fig. 2 Installing the batteries

1.3 Attaching the oxygen probe and gas sampling hose to the GX8000

The gas sampling hose has a connector to connect to the GX8000 meter on the inlet (GAS IN). Screw the oxygen probe onto the other end of the gas sampling hose.



Fig. 3 Attaching the oxygen probe and gas sampling hose

In this way, the oxygen probe can be used to carry out measurements in the open air.



This manual only addresses the use of the meter and probe connected to a soil probe and not the use of the meter for other purposes

Via a small piece of silicone tube, the oxygen probe of the GX8000 meter can be connected to the soil air probe for measurements in the soil phase. Measurements can now be carried out in the soil phase. The meter contains a motor that sucks in the air itself.

The various parts of the GX-8000 meter are shown in the next figure. Not all parts are relevant for the GX-8000 supplied with oxygen sensor.

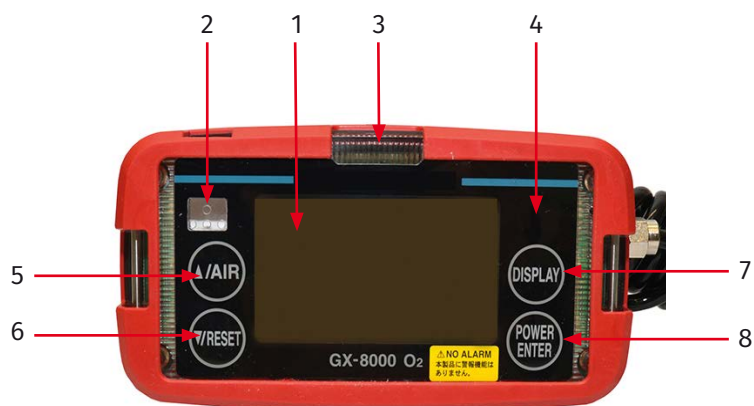

Fig. 4 GX-8000 meter

Pos.	Name	Function
1	LCD display	Displays gas concentrations, alarms, etc.
2	Buzzer sound opening	Emits a buzzer sound at an alarm. (Do not block it).
3	Alarm LED arrays	The lamp blinks in response to an alarm.
4	Infra red communication port	Used to carry out data communication with a PC in data logger mode.
5	▲/AIR switch	Keep this switch pressed to perform fresh air adjustment.
6	▼/RESET switch	When an alarm occurs, press this switch to reset the alarm.
7	DISPLAY switch	Press this switch to change between display modes.
8	POWER/ENTER switch	Turns on and off the power.

1.4 LCD Display



Fig. 5 LCD Display

Pos.	Function
1	Parameter to be measured (oxygen)
2	Numerical display and bar display measurement result %
3	Pump driving indicator
4	Clock display
5	Battery level icon

The meanings of battery level icons are as follows:

 : Sufficient

 : Low

 : Needs recharging

If the battery level is lower than the above, the inside of the battery icon starts to blink..



2. Starting and stopping the meter

The meter is turned on by pressing and holding the POWER / ENTER button for at least 3 seconds. At that moment the meter will give a sound signal once. The operation of the pump motor can now be heard.

During start up, the meter display will alternate several times before displaying the detection mode screen. During the start-up procedure, the screen of the GX-8000 meter 02 briefly shows in succession the screens with:

- all symbols visible on the screen
- date and time
- voltage of the battery
- indication of the parameters to be measured for which sensors are available (in this case only O₂);
- the programmed first alarm point
- the programmed second alarm point
- Identification screen

The meter always returns to detection mode after the start-up sequence is completed. The meter then emits two beeps. In detection mode, the measurements can be read. To stop the meter: Keep the POWER/ENTER switch pressed until the power is turned off.

3. Recording the measurements manually

Up to 256 points of data can be recorded. When the number of recorded data points reaches the maximum, recorded data will be overwritten, starting with the oldest data.

1) In the detection mode, keep the ▼/RESET switch pressed and press the ▲/AIR switch to prepare for recording (about one second). The following screens are displayed in turn on the gas monitor.

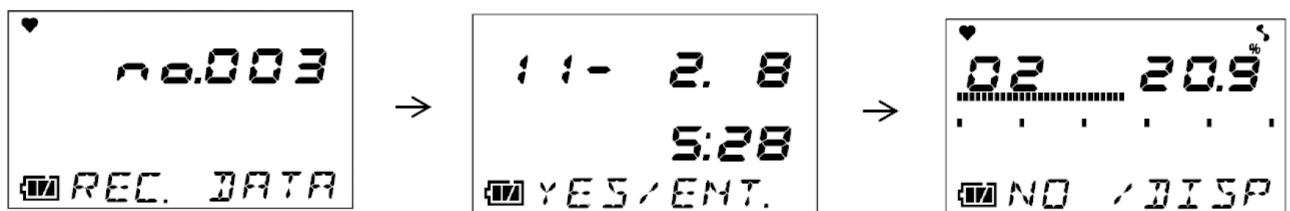

The screen displays the memory number, date, and instantaneous value in turn. Press the ENTER switch to execute recording. The date and the instantaneous value at the time when the ENTER switch is pressed are recorded. If you do not want to record a value, press the DISPLAY switch to return to the detection mode. When END is displayed, the recording is completed. In both cases, the instrument returns to detection mode.

4. Screen reading options

The GX8000 meter has several screens in addition to the (default) detection mode screen. Each time the DISPLAY button is pressed a different screen is displayed. Not all screens apply when using the meter with a soil probe:

1. **PEAK:**
This screen displays the minimum concentrations of measured oxygen, measured from the moment the meter was turned on.
2. **Full scale display/alarm setpoint display/alarm test:**
These screens show which alarm values the oxygen level meter is set to and whether the alarm is on. These screens have no added value when used in combination with the soil gas probe.

3. *Pump On/Off*

Used to turn the pump off or on again without causing the display to go out. No measurement takes place. Pressing the DISPLAY button will return the screen to the Detection screen.

4. *ID Setting*

Gives the identification number of the measurement.

5. *Log Data scherm*

Displays concentration data recorded to the manual memory.

5. Checking the soil oxygen meter set

5.1. Calibration of the meter

The oxygen measuring cell works according to an electrochemical measuring principle and lasts approximately two years. The cell must be replaced by Royal Eijkelpamp. Indications for a deteriorated performance are: deviations when measuring in fresh air (the oxygen value must be in the region of 20.9%) and / or unstable values when performing measurements in a homogeneous gas.

When the meter is turned on in a well-ventilated area, the reading should be close to 20.9%. If the reading is, for example, 21.3%, you have detected a deviation and you have calibrated the meter. The meter can easily be adjusted to the outside air (20.9%) by following the Fresh Air calibration procedure. It is recommended to do this daily before using the meter. 1 to 2 times per year, depending on the use, the meter can also be calibrated or adjusted to zero% oxygen via a One point calibration procedure. The Fresh Air Calibration procedure is explained on the next page.

Zero calibration (0% oxygen) can only be performed with a special calibration gas. See the detailed manual or send the device to Royal Eijkelpamp for this!

5.1.1 Fresh air calibration

Press and hold the *AIR* switch. The message *Adj - Hold Air* is displayed on the screen.

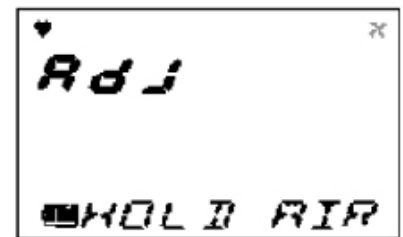
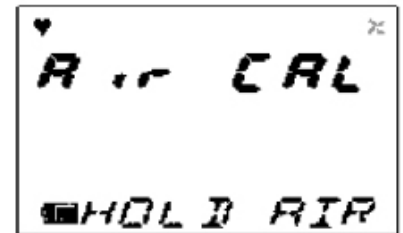
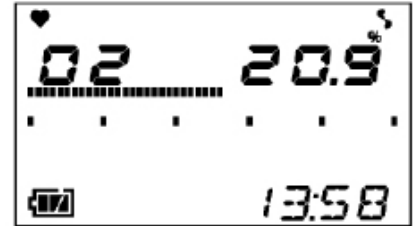

Release the *AIR* switch when *RELEASE* is displayed on the screen. There is no 30 second countdown for this meter with only an oxygen sensor.



When the adjustment procedure is finished, the meter returns to detection mode

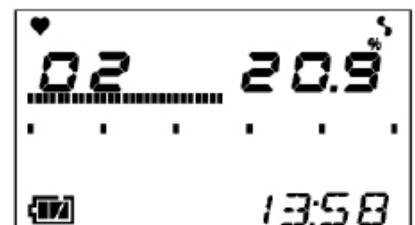

Note: In the detailed manual *Air adjustment* is also referred to as *Zero adjustment*. This applies to some sensors, but not to the oxygen sensor. This should indicate 20.9% in outdoor air.

6. Use of the soil probe with the GX-8000 oxygen meter

- Put the soil probe in the silicon hose of the soil probe.
- Push the soil probe straight down to the desired depth into the soil.



Do not hammer the soil probe. It is not designed for that!

- Pull the probe up five to ten centimeters so that the tip of the soil probe opens. Due to the special shape of the tip, only air that is locally around the tip can now be sucked up.
- Insert the probe from the GX-8000 meter into the silicone tube of the soil probe and draw air up until the meter shows a constant reading (usually after several tens of seconds).
- Read and note the measured value.
- Turn off the device and pull the probe up straight with both hands.
- Clean the tip of the probe with a dry stiff brush and check the operation of the inner pin. The device is then ready for the next measurement.



Measurements are only possible in well air-permeable soils above the groundwater level.

7. Maintenance of the soil probe

Check whether the inner pin (see fig. 6, number 1) in the bottom gas probe moves up and down properly. If necessary, clean the tip (2) with a stiff brush.

If this has insufficient effect, you must disassemble the probe. Tools are included for this.

Using the pipe wrench, remove the brass suction nipple (3) in the top of the probe (simply turn it counterclockwise).

Using the screwdriver, remove the screw with spring washer (4) that keeps the inner pin (1) from sliding out.

Remove the pin; clean pin and sleeve and slide everything back together. Refit the screw and spring washer (4) (do not use a washer as this will seal the pipe!).

Remove old PTFE tape from the suction nipple (3) and the probe. Apply new tape and carefully screw the nipple into the probe.



Make sure that the nipple is screwed straight into the probe.



Check the probe for gas leakage.

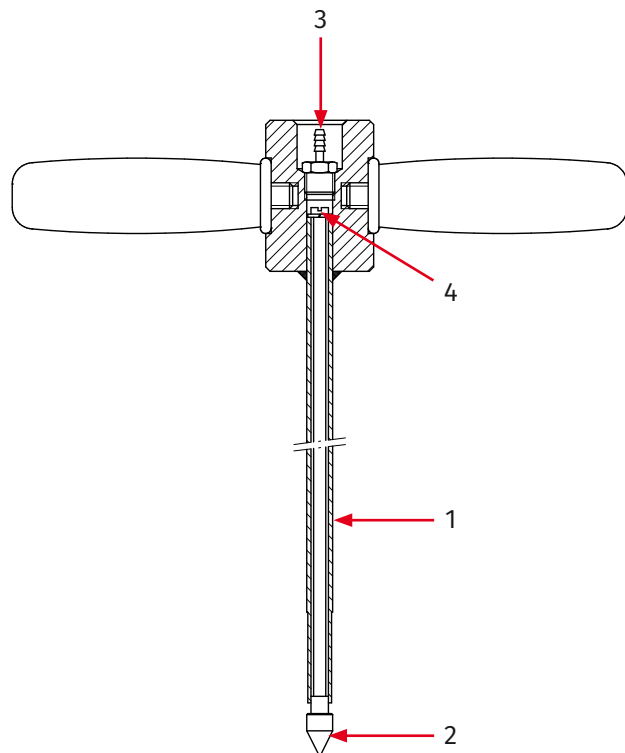

Fig. 6 Soil probe

7.1 Air pressure

If the air pressure changes (mountains, mine shafts), recalibrate to 20.9%.

7.2. Temperature

The oxygen measuring cell is temperature compensated. This compensation differs slightly per cell. It is recommended that you recalibrate the meter again to 20.9% to fresh air when entering an area with a significantly different temperature. The meter can be used from -20 °C to +50 °C.

At high temperatures, the life of the cell drastically decreases. Preferably store the meter in a cool place. For example a cool box (car) or refrigerator (at home). Do not place the meter in a freezer.

8. Specifications

Item	Specification
Oxygen meter	
Range	0 - 25% volume (0.1 %)
Calibration	Oxygen
Detection method	Electrochemical sensor
Response time	90% response within 20 seconds
Sampling method	Via pump in meter
Batteries	3 x AA alkaline 1.5 V batteries
Operating hours	> 12 h. (continuously)
Operating temperature	-20 ... +50 °C
Size	(wxhxd) 154 x 81 x 127 mm
Weight	apr. 900 gr
Soil probe	
Volume	apr. 20 cc
Handle width	285 mm
Total length of soil probe (extended tip)	907 mm
Length probe (pressed tip)	830 mm
Diameter probe	12 mm
Weight	1960 gr