

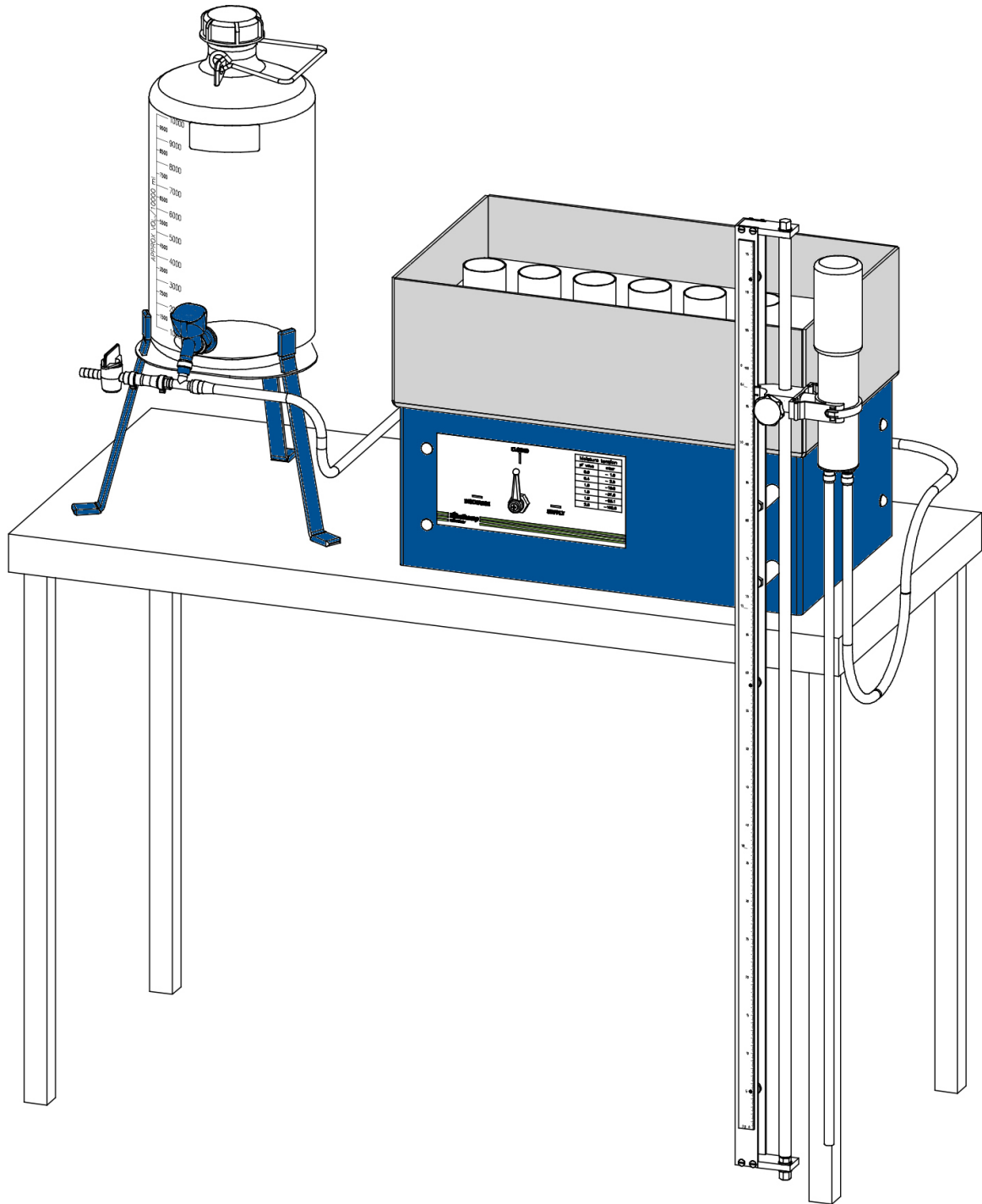

Sandbox for pF-determination

User manual



Meet the difference

Contents

| | |
|--|----|
| On these operating instructions..... | 3 |
| 1. Introduction | 3 |
| 2. Description of the sandbox..... | 3 |
| 3. Technical specifications | 4 |
| 4. Assembling the sandbox..... | 5 |
| 4.1 Before setting up the sandbox | 5 |
| 4.2 Setting up the sandbox | 7 |
| 5. Using the sandbox..... | 13 |
| 6. Table to be filled in as measurements are taken | 17 |
| 7. Troubleshooting..... | 18 |
| 8. Maintenance of suction tables | 18 |
| Appendix 1: General Information | 19 |
| Appendix 2: Description of different pF-sets | 22 |
| Appendix 3: Conversion factors..... | 23 |
| Appendix 4: Soil sampling | 24 |
| References and literature | 25 |

Nothing in this publication may be reproduced and/or made public by means of print, photocopy, microfilm or any other means without previous written permission from Royal Eijkelkamp. Technical data can be amended without prior notification.

Royal Eijkelkamp is not responsible for (personal) damage due to (improper) use of the product.

Royal Eijkelkamp is interested in your reactions and remarks about its products and operating instructions.

On these operating instructions



If the text follows a mark (as shown on the left), this means that an important instruction follows.



If the text follows a mark (as shown on the left), this means that an important warning follows relating to danger to the user or damage to the apparatus. The user is always responsible for its own personal protection.

Text

Italic indicated text indicates that the text concerned appears in writing on the display (or must be typed).

1. Introduction

This Sandbox (acc. to ISO 11274) (art. no.: 0801) can be used to apply a range of pressures from pF 0 (saturation) to pF 2.0 (-100 hPa). Sand is used to convey the suction from the drainage system to the soil samples. The surface of the sand is flexible, which makes it easier to restore the contact between it, and the samples, after they have been removed for weighing. This quality makes sand a better suction material than a stiff porous plate, for this instrument.

If the influence of higher pF-values needs to be measured, then additional equipment is required. The Sand/ Kaolin box (art. no: 0802SA) can be used to determine moisture percentages at pF-values from 2.0 (-100 hPa) to 2.7 (-500 hPa), while the pressure membrane apparatus (art. no.: 0803) can create pressures from pF 3.0 to pF 4.2. A pF-value of 4.2 is equal to -15,000 hPa of pressure, which is often taken as the lower limit of soil moisture availability to plants.

Results of measurements taken with this sandbox correspond with points on the drying curves of the relevant samples; associated with decreasing pressure. These pressure values are usually standard water potential increments. The wetting curve, on the other hand, is determined by graphing the water content against increasing pressure values. This curve is not identical to the drying curve, because the water content does not respond instantaneously to changes in pressure (Hysteresis).

2. Description of the sandbox

The assembled sandbox can be seen in Figure 1. In the bottom of the box (1) is a PVC-pipe drainage system (4). This box is filled with fine synthetic sand, which is covered with a nylon filter cloth. The assemblage stage (Chapter 4) is only necessary prior to the initial use of the sandbox: After which, with proper maintenance (Chapter 9), the sandbox can be used for several years. Soil sample core rings are placed on top of the filter cloth to take measurements.



If the sandbox has already been assembled then begin at Chapter 5.

The 'Hanging Water Principle' is used to apply suction to the soil samples. The difference in height between the suction regulator (11) and the middle of the soil samples determines the amount of pressure. Pressure heads (h) between 0 and -100 cm can be applied. The suction regulator (11) is adjusted to apply specific pressures to the soil samples. The samples are weighed after they have reached equilibrium at a specific pressure. Finally, the samples are dried and weighed to deduce the water content at each specific pressure.

3. Technical specifications

| Item | Specification |
|---|---|
| Soil sample rings (\varnothing 53mm) | Max. 40 |
| Dimensions of the box on its stand (excl. supply bottle etc.) | 55.0 x 33.5 x 37.5 cm (l x w x h) |
| Operating range | 0 hPa - 100 hPa 0 bar - 0.1 bar pF 0 - pF 2.0 |
| Reading accuracy | 0.0001 bar |

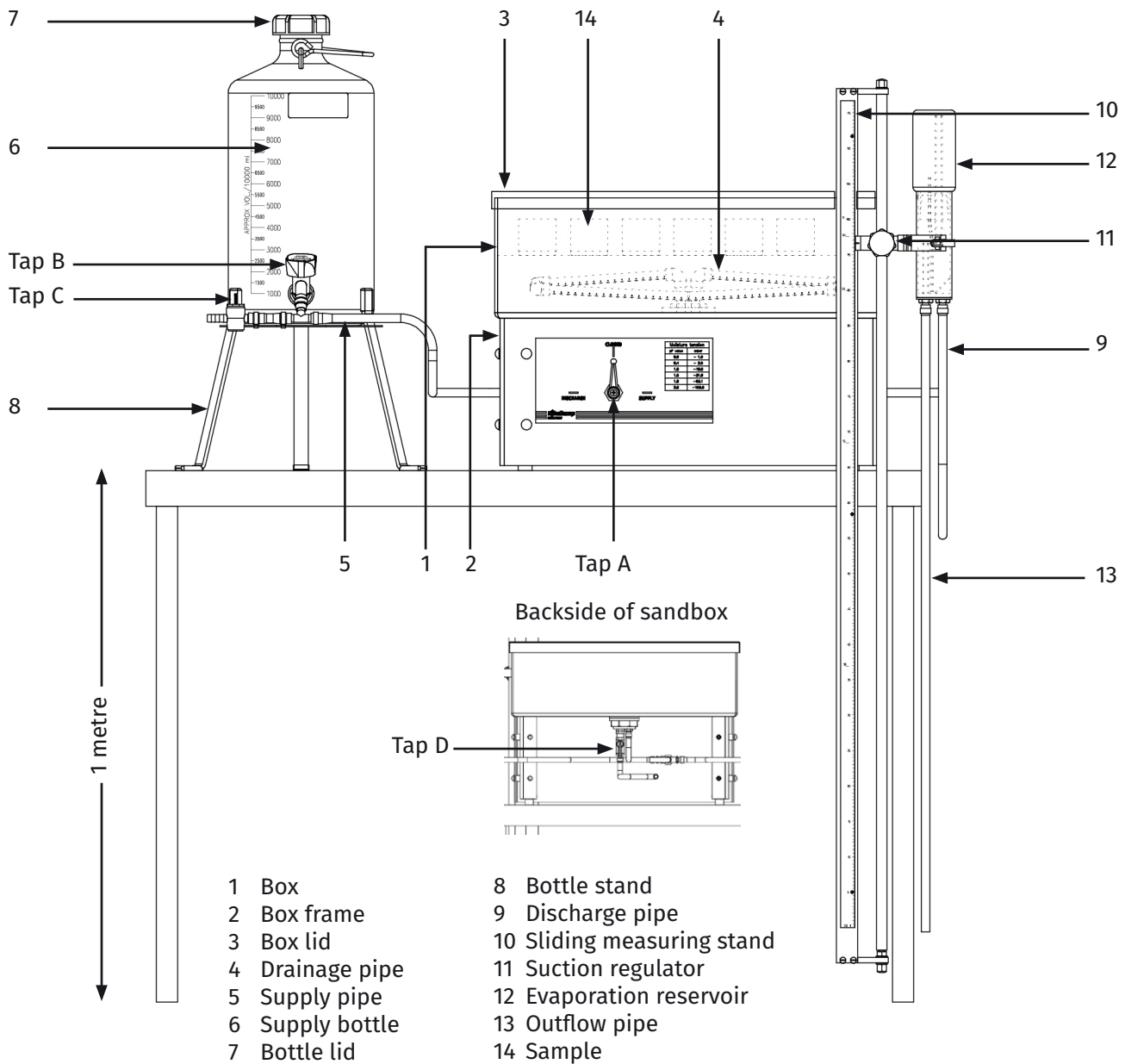

Fig. 1 : Assembled sandbox with numbered components

4. Assembling the sandbox



If the sandbox is already assembled then skip to Chapter 5.

All of the tubes are connected and tested for leakage before delivery.



Take care not to break the tube connections while unpacking.

Construct the sandbox using the following instructions (numbers refer to Figure 1).

4.1 Before setting up the sandbox

Before the sandbox is assembled, the plastic drainage pipe (4) inside the box (1) must be covered with filter cloth. The supplied filter cloth has two layers, and is 6 cm wide. The plastic drainage pipe needs to be covered by 3 layers of cloth to disperse the suction, and to stop sand from blocking the pipe's holes when this suction is applied.

To apply the filter cloth to the pipe, the following steps should be followed:

1. Cut a 3.5 m long section from the supplied roll of filter cloth.
2. Cut down one side the filter cloth to make a single 12 cm wide layer (Fig. 2).



Fig. 2 Cut 3.5 m down one side

3. To knot the cloth to the pipe, a 10 cm long section is cut into each end of the strip to form two ties (Fig. 3)



Fig. 3 The 10 cm long 'ties'

4. Saturate the filter cloth in demineralised water (Fig. 4).



Fig. 4 Saturate the filter cloth

5. Tie the filter cloth to one end of the drainage pipe - where it enters the inside of the box.

6. Coil the filter cloth around the drainage pipe so that each consecutive winding covers two thirds of the width of the previous one. This will ensure that the entire pipe is covered by three layers of filter cloth (Fig. 5).

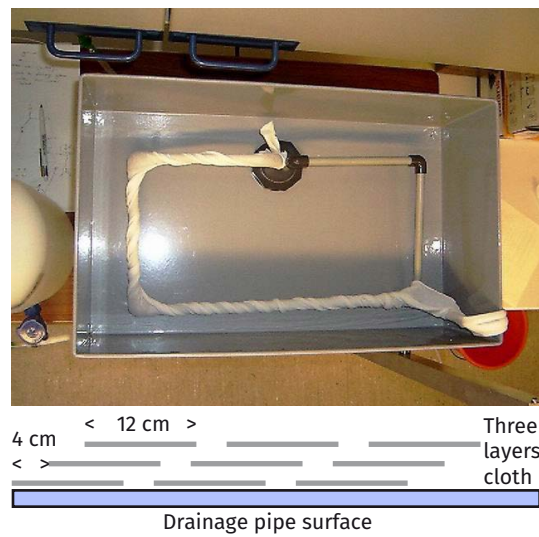

Fig. 5 Filter cloth winding

7. Fasten the cloth at the other end of the pipe.

8. Cut off the extra cloth, and tie the end to one end of the drainage pipe (Fig. 6).



Fig. 6 Complete cloth covering

4.2 Setting up the sandbox

1. Select a completely level, vibration free table that is at least 1.0 m high.



Vibration may cause a leak between the sidewalls of the box and the sand.

2. Place the sandbox on this table, with tap A facing the front and turned to the 'Closed' position (Fig. 7).

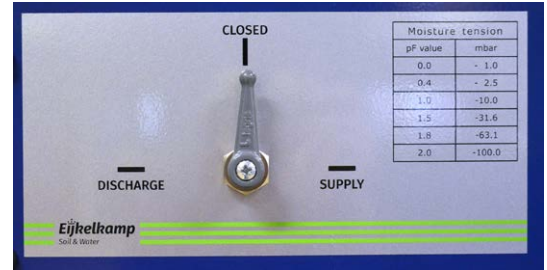

Fig. 7 Tap A 'Closed'

3. Fix the sliding measuring stand (10) with suction regulator (11) and evaporation reservoir (12) to the box (1), using the two bolts provided (Fig. 8).

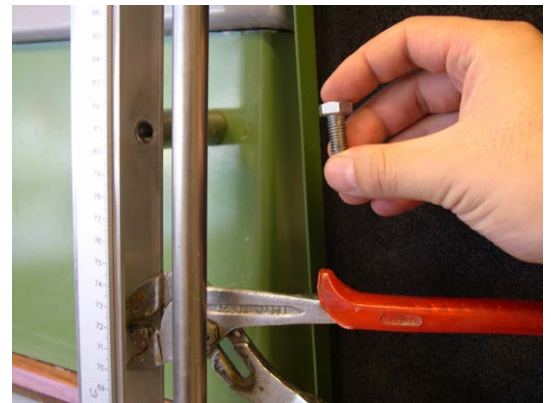

Fig. 8 Fix sliding measuring stand

4. Allow the outflow pipe (13) from the suction regulator (11) to hang from the table into a bucket (Fig. 9).
5. Boil 8 litre of demineralized water, and fill the supply bottle (6) with it once it has been left to cool (you may add Copper Sulphate to reduce algae/bacterial activity).
6. Place the supply bottle (6) on its stand (8) to the left of the box. The stand elevates the base of the bottle to the same height as the base of the box (1).



Fig. 9 Outflow from suction regulator

7. Connect the supply bottle (6) to tap A with the supply pipe from the back of the box. Leave tap A 'Closed' (Fig. 10).



You may add (0.01 mg/l) copper sulphate to reduce microbiological activity



The water level in the supply bottle should not be higher than the top of the box, because it may cause the water to flow too quickly (7500 ml).

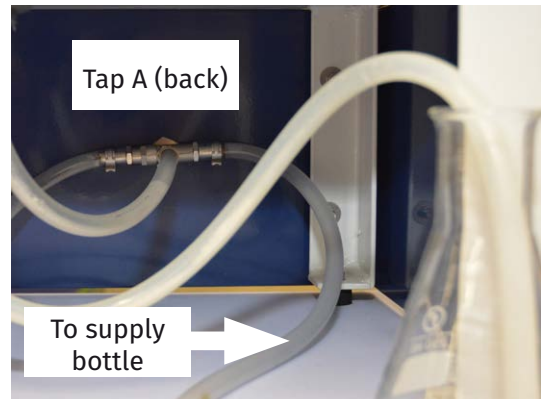

Fig. 10 Supply bottle attached to tap A

8. Air bubbles should now be removed from the piping in the system. Begin by opening the lid of the supply bottle (6), and turning the supply tap B 'On' (Fig. 11).



Fig. 11 Turn tap B 'On'

9. Turn tap A, on the front of the box, to 'Supply', and allow water to flow from the supply bottle (6) into the box (1) until the box is half-full with water (Fig. 12).

10. Turn tap A to the 'Closed' position.



Fig. 12 Half-fill box with water



The water level in the supply bottle (1) should never fall below the plastic drainage pipe inside the box (4500 ml). Turn tap A to 'Closed' when refilling the supply bottle. Let the water settle in the supply bottle before returning tap A to 'Supply'. Tap gently on the tubes as water is flowing to help bubbles escape.

11. Open tap D, at the back of the box (green) and allow some water to flow from the box (1) into a beaker (Fig. 13).



The water level in the box (1) should never fall below the plastic drainage pipe.

12. When there are no bubbles left between tap B and tap D, close tap D while leaving tap B open.
13. Turn tap A to the 'Closed' position. There should now be no bubbles between tap B and tap A, and between tap A and the drainage pipe.

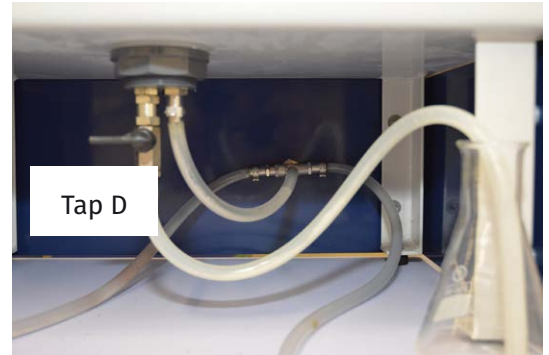

Fig. 13 Air bubbles released through tap D

14. Fill the regulator bottle of the evaporation reservoir (12) with demineralised water, and put the plug back in before replacing the bottle (Fig. 14).



Fig. 14 Evaporation reservoir

15. Set the suction regulator (11) to its lowest position (max. suction) near the bucket. (Fig. 15).
16. Turn tap A to 'Discharge', and allow water to flow from the box (1) through the suction regulator (11) into a bucket until there are no bubbles between tap A and the suction regulator (Fig. 15).

In general: if you place the tap in the discharge position, there must be a water flow from the sand box towards the suction regulator (this is the position for measurements). If the tap is placed in the supply position there is a waterflow from the supply bottle towards the sandbox. Important is to have the water level in the supply bottle always higher than the sand level in the box.



Fig. 15 Suction regulator at maximum

17. Turn tap A to the 'Closed' position.
18. Leave tap B on so that water runs out of tap C when you open it. Let some water out of tap C to remove the final air bubbles (Fig. 16).



There must be no air-bubbles in the system from this point onwards.

19. Saturate some synthetic sand with running demineralised water and stir firmly to remove air (Fig. 17). There should be a high ratio of water to sand (Fig. 18) so that it can be easily poured into the box (1). For the textural composition of the sand see Table 1.

Table 1: Textural composition of synthetic sand

| Particle diameter (m μ) | Percentage occurrence |
|------------------------------|-----------------------|
| 106 | 0 |
| 75 | 6.3 |
| 63 | 61.4 |
| 53 | 22.1 |
| 45 | 4.4 |
| <45 | 5.8 |

20. Slowly pour the water-saturated sand into the water in the sandbox (Fig. 19) while the water is constantly stirred to expel any entrapped air. Alternatively, the sand may be added with a ladle.



Be careful to avoid damaging the drain system while stirring.

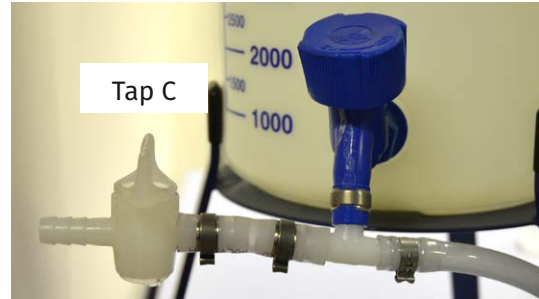

Fig. 16 Let some water out of tap C



Fig. 17 Saturate sand with water



Fig. 18 A high ratio of water to sand



Fig. 19 Adding water-saturated sand

21. The sand should be pressed against the side walls of the sandbox, and into the corners, to make sure that the sand does not contain air pockets and a good seal between sand and box is established (Fig. 20).



Fig. 20 Achieve a good seal

22. When the water level in the box becomes too high, then turn tap A to 'Discharge'. Allow the excess water to flow out into a bucket. Always retain a layer of water above the sand and drainage system (Fig. 21).

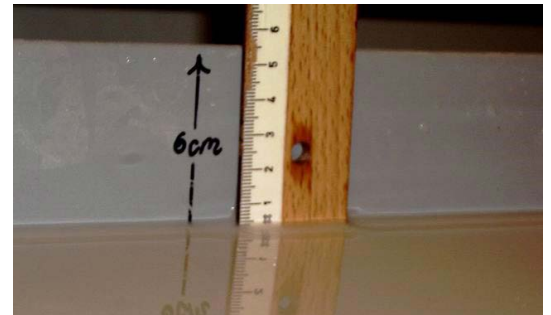

Fig. 21 Retain 0.5 cm water above the sand

23. Stop adding the saturated sand when the sand level is about 5 cm above the highest point of the plastic drainage pipe, or about 6.5 cm below the rim of the box (1) (Fig. 22).

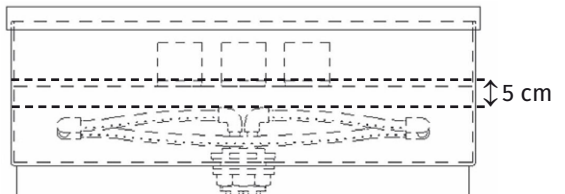

Fig. 22 Depth of the sand



There must be at least 6 cm of space between the sand and the top of the box to place the soil sample rings under the lid.

24. Excess water can now be drained – leaving 0.5 cm of water above the surface level of the sand. Put the suction regulator at its lowest point, and turn tap A to 'Discharge' (Fig. 23).



The sand level must always remain 0.5 cm under water, otherwise air will be sucked into the sand.

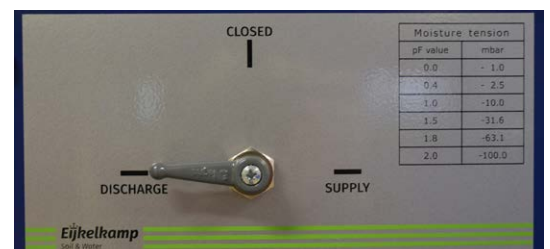

Fig. 23 Tap A 'Discharge'

25. Smoothen the surface of the sand, and leave it to settle (Fig. 24).



Fig. 24 Smoothen sand with a clean ruler

26. Turn Tap A to the 'Supply' position, and open Tap B. Water from the supply bottle will now flow through the drain and remove final air residues. Each time air appears to be entrapped, the above described procedure is repeated to remove it. (Fig. 25).

 **The supply bottle cap must be open.**

27. Once the surface layer of the sand is completely covered with a 1 cm layer of water, all taps must be closed.

28. Cover the surface area of the sand with a piece of fully saturated protection cloth.

29. Disperse any air bubbles between the protection cloth and the sand by gently smoothing from the centre outwards (Fig. 26).

30. The middle of the soil sample is used as the reference level for zero pressure. Use the omega ruler (Fig. 27) to set the zero point on the sliding ruler to the correct height.

31. Gently loosen the small screws at the back of the sliding measuring stand to allow the ruler to be adjusted.

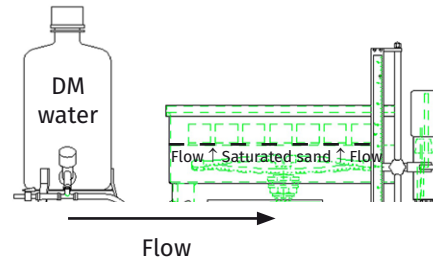

Fig. 25 Remove final air residues

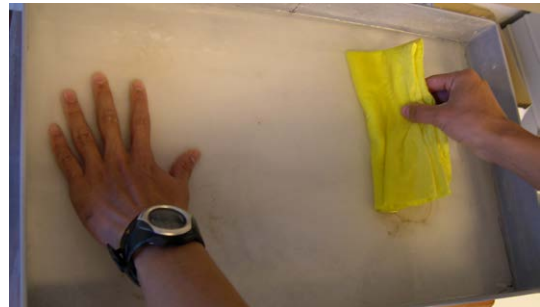

Fig. 26 Disperse bubbles under the cloth

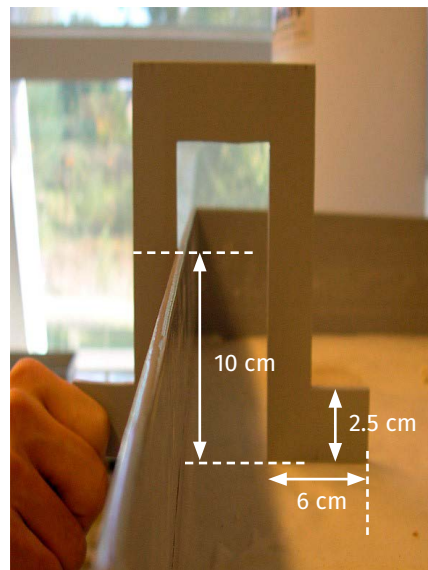

Fig. 27 Side view of the Omega ruler

32. If you are using the standard 5 cm high sample rings then the upper edge of one horizontal arm of the Omega ruler indicates the Zero point (Fig. 28) when the lower edge of the other horizontal arm is flat on the surface of the sand. (Fig. 27)
33. If you are using sample rings with a different depth then the Zero point is half the depth of that sample ring above the lower edge of the horizontal arm of the Omega ruler (sand surface).



The sandbox (art. no. 0801) is now ready to use. For instructions on how to use the sandbox please see Chapter 5.

5. Using the sandbox



The laboratory should have a constant temperature between measurements, since temperature changes affect water viscosity and therefore water retention values.

1. See Appendix 4 for how to take a proper soil sample.
2. Uncap the core sample ring. If the sampled soil volume is larger than the volume of the core ring, carefully remove excess soil by 'chipping' it off with a sharp edged tool. Prevent smearing the sample surface so as not to affect the physical properties of the soil (Fig. 29).

3. Fix a piece of nylon cloth to the bottom side (sharp edged) of the sample with an elastic-band, or an O-ring (Fig. 30). Mark the samples (see also Fig. 35).



If the soil volume is less than the volume of the ring, or if the sample has been damaged during transport, the sample should not be used for analysis. Also samples with large projecting stones may have to be discarded.

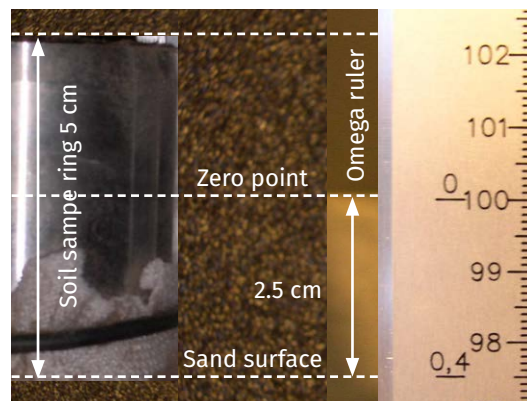

Fig. 28 End-on view of Omega ruler



Fig. 29 Chip off excess soil - don't smear!



Fig. 30 Cloth and O-ring on sample

4. Ensure that a 0.5 cm layer of water is covering the surface of the sand in the sandbox (Fig. 31).



Fig. 31 Retain 0.5 cm water above the sand

5. Place the soil sample with the bottom side down in the sandbox. Let the sample adapt for 1 hour (Fig. 32).



Fig. 32 Allow samples to adapt for 1 hour

6. To saturate the sample, Turn tap A to 'Supply' and slowly raise the water level to 1 cm below the top of the sample ring.

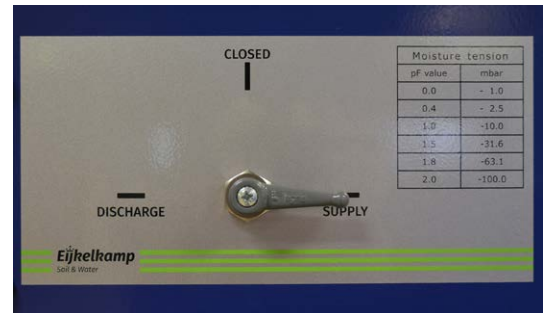

Fig. 33 Tap A in 'Supply' position



Fast raising of the water level will entrap air and may damage soil structure. (Fig. 33).

7. Turn tap A to the 'Closed' position when the water level is 1 cm below the top of the sample rings (Fig. 34).
8. Place a lid on the basin (to prevent evaporation) and allow the sample to saturate for 2 or 3 days (sandy soils) or up to 1 or 2 weeks (clayey soils).

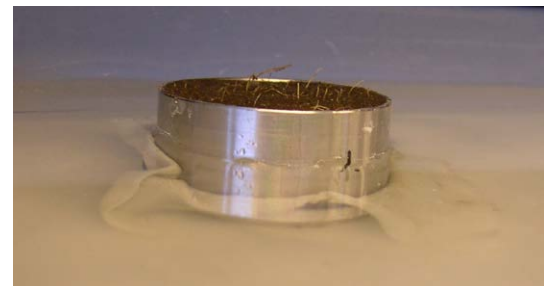

Fig. 34 Saturate sample (water 1 cm below top)



Take care not to leave sandy soils wetting for too long since slaking may occur.

9. Mark the rings, and draw a diagram of the box, so that the rings can be replaced in exactly the same place after removal (Fig. 35).



Fig. 35 Mark samples before placing them

10. Take the ring carefully out of the water basin and wipe off any water drops hanging underneath the sample before weighing it (accuracy of balance 0.01 g) (Fig. 36). This weight (including ring, cloth and elastic) is used to calculate water content at saturation, $pF\ 0$ (weight A, See Chapter 6).



Record any irregularities that occurred during saturation (e.g. swelling of clayey soils, changes in soil structure, accidental loss of soil material).

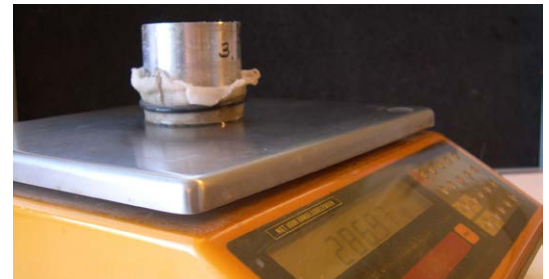

Fig. 36 Weigh the samples

Water content measurements at $pF\ 0$ are relatively inaccurate:

- It is difficult to transfer the saturated sample to a balance without changing water content, especially with sandy samples.
- The middle of the soil sample is used as the reference level for zero pressure, but the free water level ($h = 0$) is in fact 1 cm below the top of the sample ring. The moisture tension thus ranges from +1 cm at the bottom of the sample, to -4 cm at the top of the sample. Note that at lower pressures this difference due to sample size becomes less important.

11. Place the ring on the sandbox. Press the ring slightly, to improve soil - sand contact. (Fig. 37).



Fig. 37 Press to ensure soil-sand contact

12. Slide the suction regulator so that a pressure of -2.5 cm head is applied to the centre of the samples (this level is equal to the level of the sand when standard 5 cm sample rings are used) (Fig.38).

13. Leave the sample to equilibrate, (with the lid on the box to stop evaporation). This will take a few days for sandy soil and up to a week for clayey soils.

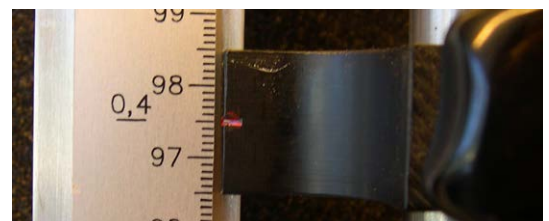

Fig. 38 Pressure of -2.5 cm head ($pF\ 0.4$)

14. Gently remove the samples and weigh them (Fig. 39).
15. To check equilibrium, place the sample on the suction table at exact the same place (take care that the contact between sand and sample is restored) and weigh the sample again the next day. In case of equilibrium with the created tension, the difference in water content will not exceed 0.002 in volume fraction.
16. If equilibrium between soil moisture content and pressure has been established, record the weight of the sample. Wipe sand grains and water drops from underneath the sample before weighing - for calculation of soil water content weight A, see Chapter 6.
17. Moisten the sand surface with a wet sponge. Don't remove the filter cloth - just clean and smoothen it at the same time to remove air bubbles and impressions (Fig. 40).

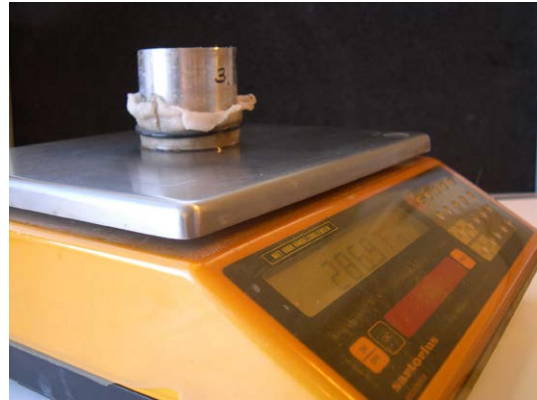

Fig. 39 Check sample reached equilibrium



Fig. 40 Clean & smooth surface

18. Replace the soil samples on the sand at exactly the same position as they were previously. (Use the diagram made earlier) (Fig. 41).



Fig. 41 Replace samples

19. Slide the suction regulator down to the next standard water potential increment, so that a greater suction is applied to the centre of the samples. For example: -10.0 cm water (pF 1.0), -31.6 cm water (pF 1.5), -63.1 cm water (pF 1.8) and -100 cm water (pF 2.0). (Fig. 42)
20. Wait for soil-water equilibrium (Eg. 2 to 3 days for sand and longer for clay).
21. Repeat steps 10–19 until weights have been recorded at each of the potential increments that you want to measure.



Fig. 42 Replace samples



Always replace the samples on the sand before moving the suction regulator.

6. Table to be filled in as measurements are taken

| Sample number | Ring number | pF | Cm water column (potential in hPa) | Weight (g) | | | | | V = Volume of core ring =cm ³ | | | |
|---------------|-------------|-----|------------------------------------|---|---|----------------------------------|--------------------------------|------------------------------|--|--|--|--|
| | | | | Wet weight (sample, ring, cloth, elastic) A | Dry weight (sample, ring, cloth, elastic) B | Weight of ring, cloth, elastic C | Weight of soil water D = A - B | Weight of dry soil E = B - C | Gravim. water content W = D / E | Bulk density (g / cm ³) $\rho_d = E / V$ | Volum. Water content $\theta = W * \rho_d$ | |
| | | 0,0 | 1,0 | | | | | | | | | |
| | | 0,4 | 2,5 | | | | | | | | | |
| | | 1,0 | 10 | | | | | | | | | |
| | | 1,5 | 31,6 | | | | | | | | | |
| | | 1,8 | 63,1 | | | | | | | | | |
| | | 2,0 | 100 | | | | | | | | | |

7. Troubleshooting

| Problem | Possible causes | Solution(s) |
|---|--|--|
| Air in the tube between the supply bottle and the suction regulator is distorting the measurements. | 1. There are air bubbles in the water. | 1. Only use the water if it's calm. Let the supply bottle stand still for a while before using the water. De-aerate the tube. |
| | 2. There is not enough sand above the drainage pipe inside the box. | 2. Add more water-saturated sand. The sand level should be at least 5 cm above the highest point of the drainage pipe. |
| | 3. Air is entering via the side walls of the box because sand wasn't pressed against the walls properly during the setting-up stage, or vibration has broken the seal. | 3. Remove the sand from the sandbox and begin the setting up process again at step 9. Ensure that the sand is completely saturated, and that it is forced into the corners, and against the walls, of the box. |
| | 4. There is a leaking cock/tap. | 4. Order a new cock/tap. |

8. Maintenance of suction tables

To prevent pores from becoming clogged by algae or bacterial growth, the suction tables should be flushed once or twice a year with a solution of hot water, and possibly with acetic acid to prevent calcium deposits.

The suction tables must be flushed until only clean water emerges. A copper washer is placed in the suction regulator to prevent algae growth. Diluted copper sulphate may be added to the water in the supply bottle for the same reason. Rather than flushing the suction table, it is also an option to change the sand or the sand and totally refill the box.

It is recommended to regularly wash the filter cloth that covers the sandbox.

Whenever the sand suction table is not in use, sand should be immersed in water and a suction level of 100 hPa (pF 2) should be retained.

Appendix 1: General Information

The pF-curves plotted below will be used to illustrate the soil physical characteristics that can be deduced from pF-curves. The example soil contains three different soil horizons (each of which has a known pF-Curve). These curves are referred to in Table 3.

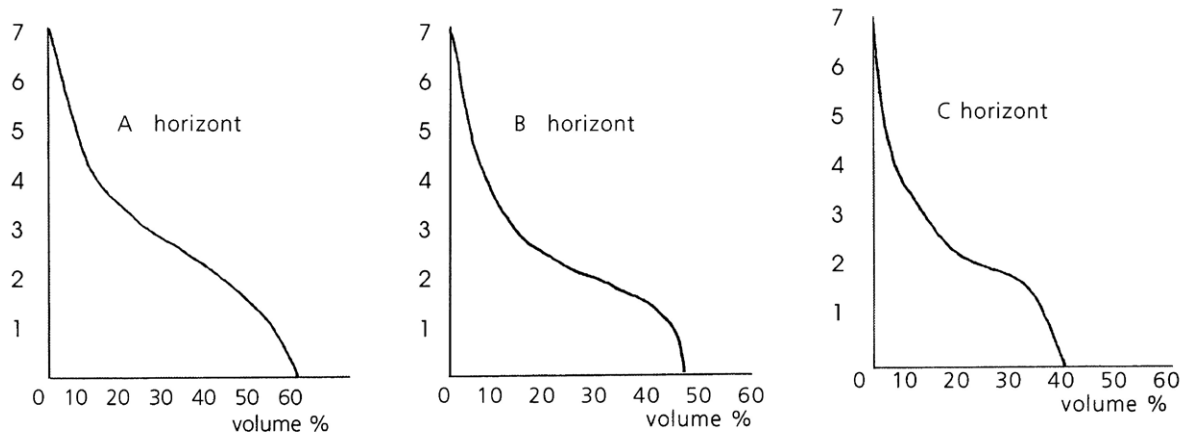

| Physical characteristic | Definition and how to determine |
|-------------------------------|--|
| Moisture content | Volume fraction of water filled pores at a certain matric potential. For example, at a matric potential of 1000 hPa (1 bar, pF 3.0), the A horizon has a volumetric moisture content of 20%. |
| Field capacity (FC) | Moisture content at pF 2 The A horizon has a moisture content of 35% at FC and the C horizon 24%. |
| Permanent wilting point (PWP) | Moisture content at pF 4.2 The A horizon has a moisture content of 8% at PWP and the C horizon 4%. |
| Porosity | In a sandy soil, all pores are filled with water at saturation (pF 0), and empty when oven-dry (pF 7). Therefore, the volume percentage between pF 0 and pF 7 is equal to the porosity in a sandy soil. In a clay soil porosity, or total pore volume, depends upon moisture content, due to swelling and shrinking. Therefore, for clay soil porosity cannot be determined from the pF-curve. The example soil is a loamy sand soil, and allows estimating porosity: At saturation, the A horizon has a volumetric moisture content of 50%, when the soil is oven dry the moisture content is 0%, therefore, 50% of the soil volume is pore space, filled with water and air, and porosity is 50%. |
| Volume fraction solid matter | Total volume fraction minus porosity. Since porosity of the A horizon is 50%, the volume fraction of pores is 0.5 and volume fraction of solid matter in the A horizon is $1 - 0.5 = 0.5$ |

| Physical characteristic | Definition and how to determine |
|-------------------------|--|
| Aeration status | <p>Volume of available air: porosity minus moisture content. Depending on crop type, a certain ratio between water and air supply is required for optimal crop growth.</p> <p>In the example soil, (A horizon) at a moisture potential of 1000 hPa (pF 3), moisture content is 20%, total pore space is 50%, so the volume of available air is 30%.</p> |
| Pore size distribution | <p>Shape of pF curve: Pores of similar size will be emptied at the same matric potential. The more homogenous the pore size distribution, the faster the drop in soil moisture content upon a small decrease in matric potential, and the flatter the slope of the pF curve. The steeper the slope, the more gradual the emptying of soil pores, the more heterogeneous the pore size distribution.</p> <p>In general, a heterogeneous pore size distribution is preferable for agricultural applications, since these soils have a higher water holding capacity.</p> <p>The example soil illustrates the effect of organic matter presence and biological activity in the A horizon. In the A horizon, the slope of the pF-curve is more gradual than in the C horizon, meaning that pores are emptied more gradually in the A horizon, corresponding to a heterogeneous pore size distribution. The C horizon contains a relatively large amount of pores of similar size, which are all drained around a matric potential of - 100 hPa (pF 2). A slight increase in the suction will lead to a change in moisture content of almost 10%.</p> |
| Capillary conductivity | <p>The rate of capillary conductivity depends upon the amount and size of water filled pores involved in water flow. This depends upon the moisture potential of the soil.</p> <p>A decrease of the water potential (an increase in suction level) corresponds with a decrease in moisture content. Because water is forced to flow through narrow pores with a high friction, this consequently leads to a reduction in the capillary motion.</p> <p>Permeability rate depends on the distribution and amount of macro-pores.</p> |
| Storage capacity | <p>Storage capacity of a soil at a specific ground water level corresponds to the air volume present. Storage capability is expressed in mm water per decimetre of soil (1 mm water per 10 cm \approx 1 volume percent).</p> <p>For the example soil, the storage capacity of the C horizon at a moisture tension of 100 hPa (pF 2) is calculated as total pore space (40%) - moisture content (25%) = volume of air (15%). A volumetric air content of 15% corresponds to a storage capacity of 15 mm of water per decimetre of C horizon.</p> |

| Physical characteristic | Definition and how to determine |
|----------------------------|---|
| Plant available soil water | <p>The amount of water between FC and PWP in volume percentage. This value should be used with caution. First, plants will start wilting with subsequent yield losses well before the permanent wilting point. Secondly, plant available soil water is replenished by capillary rise, rainfall and irrigation water.</p> <p>Eg: A fine sandy soil, rich in loam has a rooting depth of about 40 cm.</p> <ul style="list-style-type: none"> • The A horizon has a depth of 20 cm. • The B horizon has a depth of 30 cm. <p>Calculation of the amount of plant available soil water:</p> <p>At field capacity, pF 2.0, the A horizon will contain 35 volume % of water. At the permanent wilting point, pF 4.2, the A horizon will contain 8 volume % of water. As 1 volume % corresponds to 1 mm water per 10 cm of soil, the amount of available soil water in the A horizon is calculated as the volume % of water multiplied with the rooted depth of the soil horizon:</p> <p>A horizon: $35 - 8 = 27$ volume % water x 20 cm soil depth 27×2 dm soil depth = 54 mm</p> <p>For the B horizon the calculation is similar. Notice that rooting depth is 40 cm, so roots will be present only in the upper 20 cm of the B horizon. At field capacity 27% of water will be available, at the permanent wilting point only 6%.</p> <p>B horizon: $27 - 6 = 21$ volume % of water * 20 cm rooted soil depth $\div 21 \times 2 = 42$ mm water</p> <p>In total, $54 + 42 = 96$ mm of water is available to plant growth in this particular soil.</p> |

Appendix 2: Description of different pF-sets

To determine the soil moisture retention characteristic, the desired pF-set(s) is/are required. A balance with an accuracy of 0.01 g, and a ventilated electrical drying oven (105 °C), are also necessary. Royal Eijkelpamp supplies the following:

A sandbox for pF determination (pF0 -2.0). The standard set (art. no. 0801) for about 40 samples includes:

- Sandbox
- Containers with synthetic sand, particle size \pm 73 μ m, 12.5 kg each
- Filter cloth, 140-150 mm
- Set of 65 o-rings, diameter 49x3 mm: suitable for 5 cm diameter core rings
- Omega ruler

A Sand/kaolin box for pF determination (pF2.0 - 2.7). The standard set (art. no. 0802SA) for about 40 samples includes:

- Sand/kaolin box
- Suction level control system, power supply 110-230 Vac (47/63 Hz)/24 Vdc
- Containers with synthetic sand, particle size \pm 73 μ m, 12.5 kg each
- Filter cloth, 140-150 mm
- Kaolin clay, container 2.5 kg
- Set of 65 o-rings, diameter 49x3 mm: suitable for 5 cm diameter core rings

Pressure membrane apparatus (pF3.0 – 4.2). The standard set (art. no. 0803) for about 15 samples includes:

- Pressure membrane extractor
- Cellophane membrane
- Soil sample retaining rings diameter 40x36 mm
- Filter cloth 140 - 150 mm
- Compressor 20 bar
- Air filter with support and hose

Appendix 3: Conversion factors

100 hPa = 100 cm pressure head
= 100 cm water column
= 0.1 bar
= 0.01 Pa
= 0.01 N/m²
= 1.45 PSI
= pF (10log100) = 2.0

| pF value | Matric potential in hPa | Pressure in bar |
|----------|----------------------------|--------------------|
| 0 | 1 | -0.001 |
| 0.4 | 2.5 | -0.0025 |
| 1.0 | 10 | -0.01 |
| 1.5 | 31.6 | -0.0316 |
| 1.8 | 63.1 | -0.0631 |
| 2.0 | 100 | -0.1 |
| 2.3 | 200 | -0.2 |
| 2.7 | 500 | -0.5 |

Appendix 4: Soil sampling

To determine the moisture retention characteristic or the pF-curve of a specific soil, undisturbed core samples must be collected. This is because of the major influences of both pore size distribution and soil structure on moisture retention, especially at the high matrix potentials of the operating range of suction tables.

There is no explicit prescription in literature for recommended sample sizes. Optimal sizes for core rings are determined by the size of structural elements in the soil. To obtain representative data, sample sizes should be large with respect to the size of soil aggregates, cracks, root channels or animal holes. From a practical point of view, sample diameters should not be too large as not to reduce the amount of simultaneously analysable samples, and sample height should be constrained to several centimeters; so that equilibrium conditions are reached in a reasonable period of time.

According to the Dutch NEN 5787 standard, samples with a volume between 100 and 300 cm³ are usually used for the suction tables, while samples with a height of more than 5 cm are discouraged, because the time needed to establish equilibrium will be long, and the accuracy of determination of pF-values near saturation will be low. In the procedures for soil analyses of the International Soil Reference and Information Centre (ISRIC), sample rings with a diameter of 5 cm and a volume of 100 cm³ are recommended, while in other publications heights of 2 or 3 cm are preferred.

Royal Eijkelkamp recommends the use of a 100 cm³ volume core ring, with an inner diameter of 50 mm (outer diameter 53 mm) and a height of 51 mm.

When pressing the core rings into the soil, care should be taken not to disturb the original setting of the soil and to completely fill the ring. Sampling conditions are best when the soil is approximately at field capacity. Royal Eijkelkamp supplies a number of standard soil sample ring kits (with art. no: 0753SA, 0753SC and 0753SE (for rings Ø 53 mm), 0760SC for rings Ø 60 mm and 0784SC for rings with Ø 84 mm).

Ring holders may be used to facilitate insertion, especially in the subsoil. After insertion to the desired depth, the rings are carefully dug out (e.g. using the spatula provided with the Eijkelkamp sample ring sets), at some centimeters below the ring itself. The surplus of soil is reduced to a few millimeters, trimming it carefully with a fine iron saw, and the caps are placed on the ring for protection and to minimise evaporation losses. The remaining surplus of soil will protect the sample during transport and will be removed in the laboratory, prior to analysis. Transport the core rings in a protective case (art. no. 070201 for Ø 53 mm or 070202 for Ø 60/84 mm).

Since soil structure and pore size distribution have significant influence on soil water retention, several replicate samples are needed to obtain a representative pF-value. Depending on natural variability of the study area, three to six replicate samples per unit are advised.

In case the samples cannot be analysed on short notice, store the samples in a refrigerator to reduce microbial activity which might cause non-representative changes in soil structure.



Do not freeze the samples because soil structure will be influenced.

References and literature

Klute, A. Water Retention: Laboratory Methods. IN: Methods of Soil Analysis. Part 1. Physical and Mineralogical Methods. 1986.

Koorevaar, P., G. Menelik and C. Dirksen. Elements of Soil Physics Developments in Soil Science 13 1983

Reeve, M.J. and A.D. Carter. Water Release Characteristic. IN: Soil Analysis. Physical Methods. K.A. Smith and C.E. Mullins (eds.) 1991.

Van Reeuwijk, L.P. (ed.) Procedures for soil analysis. 1995. ISRIC Wageningen.

Stakman, W.P., G.A.Valk and G.G. van der Harst. Determination of soil moisture retention curves I. 1969. ICW Wageningen.

Stolte (ed.) Manual for soil physical measurements. Version 3. Technical Document 37. SC-DLO. 1997.

Topp, G.C. and W. Zebchuk. The determination of soil water desorption curves for soil cores. 1979. Canadian Journal of Soil Science 59: 19-26.