

Operating Manual

Conductivity measuring device waterproof, with data logger and alarm

GMH 5450



Companies / Brands of the GHM
Members of GHM GROUP:

GREISINGER
HONSBURG
Martens
IMTRON
DeltaOHM
VAL.CO

www.ghm-group.de

Keep for later use.

Index

1	GENERAL NOTE	3
2	SAFETY	3
2.1	INTENDED USE.....	3
2.2	SAFETY SIGNS AND SYMBOLS.....	3
2.3	SAFETY GUIDELINES	3
3	PRODUCT SPECIFICATION	4
3.1	SCOPE OF SUPPLY	4
3.2	OPERATION AND MAINTENANCE ADVICE	4
4	HANDLING	5
4.1	DISPLAY ELEMENTS.....	5
4.2	PUSHBUTTONS	5
4.3	CONNECTIONS	6
4.4	POP-UP CLIP	6
5	START OPERATION	7
6	PRINCIPLES OF THE MEASUREMENTS	7
6.1	BASICS ABOUT CONDUCTIVITY	7
6.2	MEASURING RANGES AND CELL CONSTANTS	7
6.3	CONDUCTIVITY MEASUREMENT	8
6.4	RESISTIVITY MEASUREMENT	8
6.5	TDS MEASUREMENT.....	8
6.6	SALINITY MEASUREMENT.....	9
6.7	ELECTRODES / MEASURING CELLS.....	9
6.7.1	<i>Assignment bayonet-connector</i>	9
6.7.2	<i>Design and selection</i>	9
6.7.3	<i>Calibration / Adjustment of measuring cells</i>	10
6.8	TEMPERATURE COMPENSATION	10
6.8.1	<i>Temperature compensation "nLF" according to EN 27888</i>	10
6.8.2	<i>Linear temperature compensation and determination of temperature coefficient "t.Lin"</i>	10
7	CONFIGURATION	10
8	DATA LOGGER	13
8.1	MANUAL RECORDING ("FUNC-STOR").....	13
8.2	AUTOMATIC RECORDING WITH SELECTABLE CYCLE TIME "FUNC CYCL"	14
9	UNIVERSAL OUTPUT	15
9.1	INTERFACE.....	15
9.2	ANALOG OUTPUT.....	16
10	ADJUSTMENT OF TEMPERATURE INPUT	16
11	AUTOMATIC ADJUSTMENT/CALIBRATION OF CELL CONSTANT	17
12	GLP	17
12.1	CALIBRATION INTERVAL (C.INT).....	18
12.2	CALIBRATION MEMORY (READ CAL)	18
13	ALARM ("AL.")	18
14	REAL TIME CLOCK ("CLOC")	18
15	ACCURACY CHECK / ADJUSTMENT SERVICE	19
16	REPLACING BATTERIES	19
17	ERROR AND SYSTEM MESSAGES	20
18	RESHIPMENT AND DISPOSAL	21
18.1	RESHIPMENT	21
18.2	DISPOSAL INSTRUCTIONS.....	21
19	SPECIFICATION	21

1 General Note

Read this document carefully and get used to the operation of the device before you use it. Keep this document within easy reach near the device for consulting in case of doubt.

2 Safety

2.1 Intended Use

The device is designed for measuring conductivity, resistivity, salinity and TDS in fluids – using external suitable electrodes (measuring cells). It is designed for the mobile use or the stationary operation in a controlled electromagnetic environment (lab). The electrodes are connected via 7-pole bayonet connection.

Please consider: Depending on the measuring range different electrode types may be needed – choose an appropriate one.

Personnel which starts up, operates and maintains the device has to have sufficient knowledge of the measuring procedure and the meaning of the resulting measured values, this manual delivers a valuable help for this. The instructions of the manual have to be understood, regarded and followed.

To be sure that there's no risk arising due to misinterpretation of measured values, the operator must have further knowledge in case of doubt - the user is liable for any harm/damage resulting from misinterpretation due to insufficient knowledge.

The manufacturer will assume no liability or warranty in case of usage for other purpose than the intended one, ignoring this manual, operating by unqualified staff as well as unauthorized modifications to the device.

2.2 Safety signs and symbols

Warnings are labeled in this document with the followings signs:



Caution! This symbol warns of imminent danger, death, serious injuries and significant damage to property at non-observance.



Attention! This symbol warns of possible dangers or dangerous situations which can provoke damage to the device or environment at non-observance.



Note! This symbol point out processes which can indirectly influence operation or provoke unforeseen reactions at non-observance.

2.3 Safety guidelines

This device has been designed and tested in accordance with the safety regulations for electronic devices. However, its trouble-free operation and reliability cannot be guaranteed unless the standard safety measures and special safety advises given in this manual will be adhered to when using the device.

1. Trouble-free operation and reliability of the device can only be guaranteed if the device is not subjected to any other climatic conditions than those stated under "Specification".

If the device is transported from a cold to a warm environment condensation may cause in a failure of the function. In such a case make sure the device temperature has adjusted to the ambient temperature before trying a new start-up.

2.  If there is a risk whatsoever involved in running it, the device has to be switched off immediately and to be marked accordingly to avoid re-starting.

Operator safety may be a risk if:

- there is visible damage to the device
- the device is not working as specified
- the device has been stored under unsuitable conditions for a longer time.

In case of doubt, please return device to manufacturer for repair or maintenance.

3. When connecting the device to other devices the connection has to be designed most thoroughly as internal connections in third-party devices (e.g. connection GND with protective earth) may lead to undesired voltage potentials that can lead to malfunctions or destroying of the instrument and the connected devices.



This device must not be run with a defective or damaged power supply unit.
Danger to life due to electrical shock!

4.  Do not use these products as safety or emergency stop devices or in any other application where failure of the product could result in personal injury or material damage. Failure to comply with these instructions could result in death or serious injury and material damage.

5.  This device must not be used at potentially explosive areas! The usage of this device at potentially explosive areas increases danger of deflagration, explosion or fire due to sparking.

3 Product Specification

3.1 Scope of supply

The scope of supply includes:

- GMH 5450 with 2 AAA batteries
- Operating manual
- Short form manual

3.2 Operation and maintenance advice

1. Temperature measuring / sensor connection:

There is the possibility to connect a temperature sensor (Pt1000 or NTC 10k) to the 7-pole bayonet socket. Generally a suitable temperature sensor is included to the measuring cell. The measured temperature is used for the automatic temperature compensation (e.g. Lin or nLF) and is additionally displayed.

2. Battery operation:

If 'bAt' is shown in the lower display the battery has been used up and needs to be replaced. However, the device will operate correctly for a certain time. If 'bAt' is shown in the upper display the voltage is too low to operate the device; the battery has been completely used up. Battery change: p.r.t. chapter 16.



*The battery has to be taken out, when storing device above 50°C. We recommend taking out battery if device is not used for a longer period of time.
After recommissioning the real-time clock has to be set again.*

3. Treat device and sensor carefully. Use only in accordance with above specification. (do not throw, hit against etc.). Protect plug and socket from soiling.

4. USB or mains operation:

When connecting a mains cable or USB interface cable, please take care to connect only allowed components.



The output voltage of a connected power supply unit has to be between 4.5 and 5.5 V DC.
Don't apply overvoltage!

We recommend operation with interface cable USB 5100. Then device is supplied by the USB interface of the connected PC or USB power supply adapter.

4 Handling

4.1 Display elements

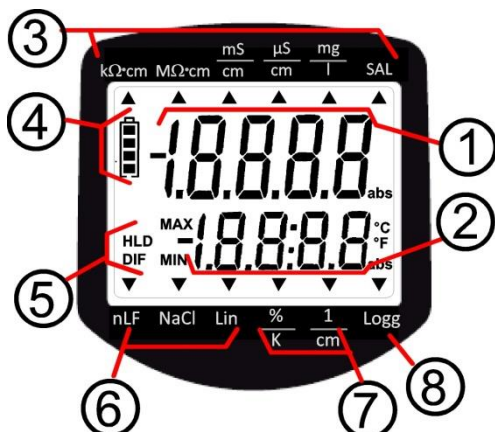

- 1 **Main display:** conductivity (mS/cm, μ S/cm)
resistivity (k Ω cm, M Ω cm)
TDS / total dissolved solids (mg/l)
salinity (SAL)

- 2 **Secondary display:** measuring value temperature

- 3 Arrows to selected **measuring unit**

- 4 Rating of battery state

- 5 Display elements to show minimum / maximum / memorized measuring value

- 6 **nLF, NaCl, Lin:** display element for selected **temperature compensation**

- 7 **%/K, 1/cm:** additional configuration units

- 8 **logg-arrow:** logger is ready
arrow flashing: automatic recording (Logg CYCL) is active

4.2 Pushbuttons

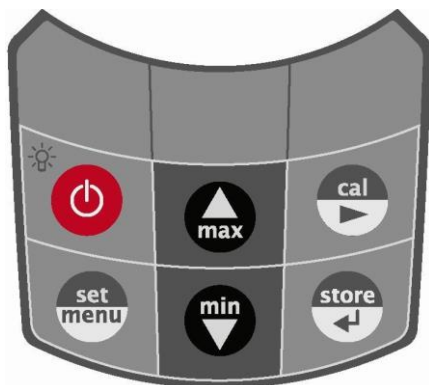

On / off key, backlight

press shortly: activate backlight or switch on instrument
press longer: switch off instrument



set / menu:

press shortly: Change unit in display (if "InP: Set")
press for 2 sec. (menu): invoke configuration menu



min / max:

press shortly: min. or max. value is displayed
press for 2 sec: the corresponding value is deleted



cal: only at mode 'cond'=conductivity:

press for 2 sec: start cell constant adjustment



store / enter:

Logger off: hold and save current measuring value ('HLD' is displayed)
Logger on: Operation of data logger – chapter 8
Set/Menu: confirm settings, return to measuring

4.3 Connections



Universal output: interface, supply, analog output (see chapter 9 Universal Output)

7-pole bayonet socket: connection for electrode / measuring cell and temperature probe



Use of bayonet-connectors:

Lock/ unlock with turnable ring at cable socket



Protect contacts from moisture and soiling!

4.4 Pop-up clip

Handling:

- Pull at label “open” in order to swing open the pop-up clip.
- Pull at label “open” again to swing open the pop-up clip further.

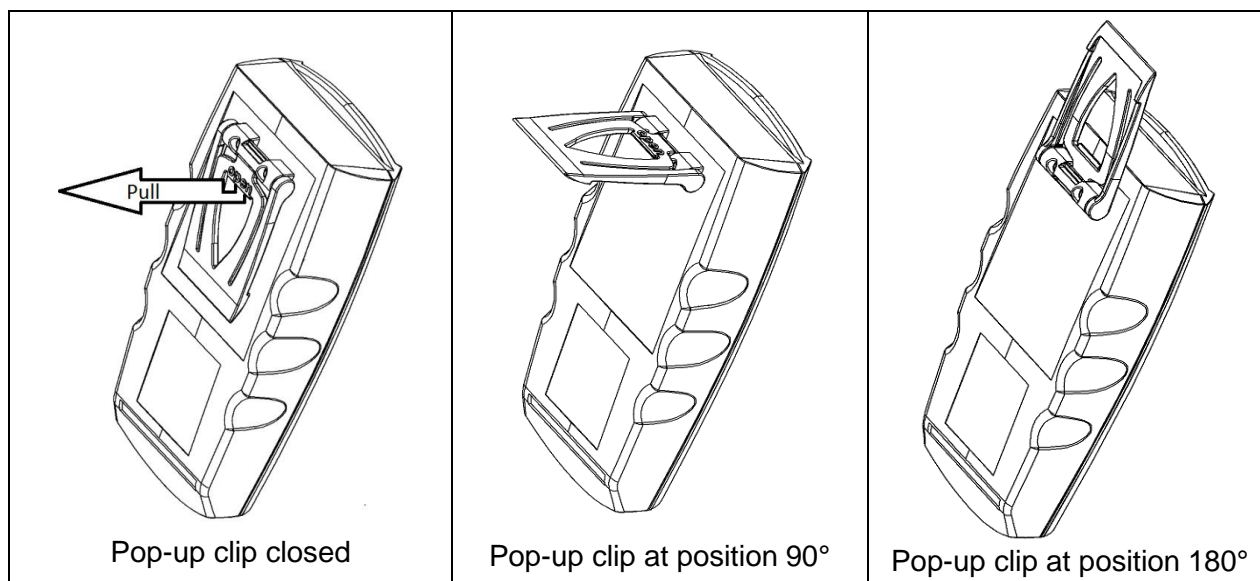

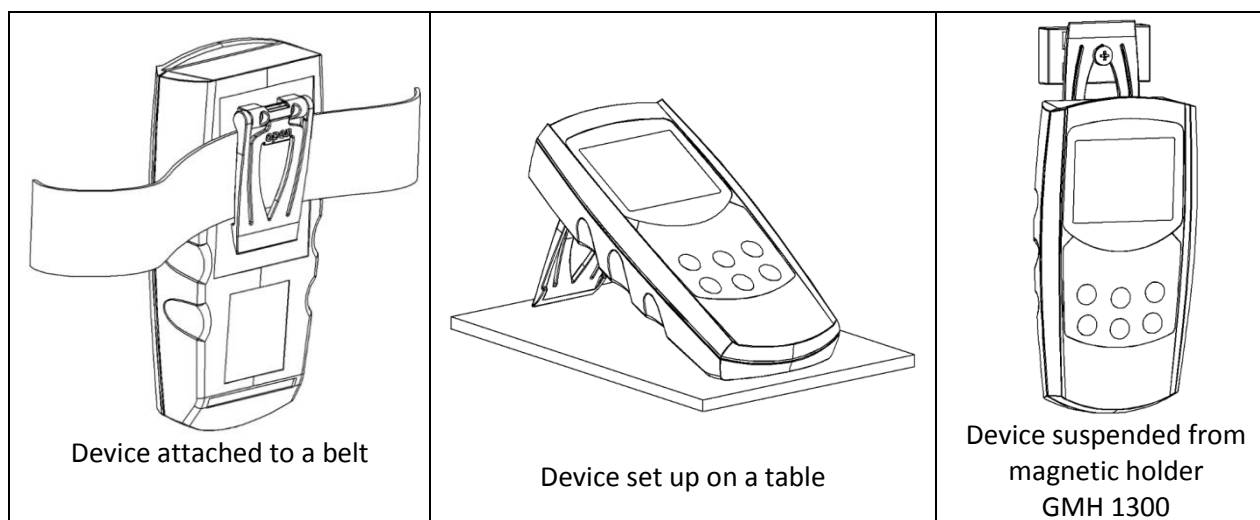

Function:

- The device with a closed pop-up clip can be plainly laid onto a table or attached to a belt, etc.
- The device with pop-up clip at position 90° can be set up on a table, etc.
- The device with pop-up clip at position 180° can be suspended from a screw or the magnetic holder GMH 1300.



5 Start Operation

Connect electrodes, turn device on via  key.

After segment test  the device displays some information on its configuration:
 [corr] if zero point or slope correction is active
 (see chapter 10 Adjustment of Temperature Input)



If a measuring cell will be connected to the instrument the first time or if the measuring cell was changed, the referring cell parameters in the instrument have to be entered, before measuring:

 Please refer to chapter Configuration
 After that the device is ready for measuring.

6 Principles of the Measurements

6.1 Basics about conductivity

Definition of conductivity: The ability of a material to conduct electric current: $\gamma = \frac{1}{R \cdot A}$

l: length of the material
 A: diameter
 R: measured resistance

Unit $[\gamma] = \frac{\text{Siemens}}{\text{meter}} = \frac{\text{S}}{\text{m}}$, common for liquids: $\frac{\text{mS}}{\text{cm}}$ and $\frac{\mu\text{S}}{\text{cm}}$

The conductivity is the reciprocal value of the resistivity.

(The conductance is the reciprocal value of the measured resistance R)

6.2 Measuring ranges and cell constants

Different measuring ranges can be realized depending on the used electrode. Therefore the device offers four cell constant ranges to choose, depending on the correspondent cell constant K:

CELL rAnG	Selectable cell constant K	Application
0.01	0.004000 - 0.015000•1/cm	Ultra-pure water, electrodes with K = 0.01
0.1	0.04000 - 0.15000•1/cm	Ultra-pure water, electrodes with K = 0.1
1	0.4000 - 1.5000•1/cm	Standard electrodes e.g. with K= 0.55 or K=1
10	4.000 - 15.000 •1/cm	Electrodes with K=10 (for extremely high conductivities)

The cell constant can be selected manually in the configuration menu (see chapter 7 "Configuration") or with the adjustment/calibration function. Then there are two possibilities:

- automatically with a reference solution (temperature compensated)
- adjustment/calibration of the displayed value if actual value of solution is known

6.3 Conductivity measurement

The conductivity measurement is a rather uncomplicated measurement. The standard electrodes are stable for a long time if used correctly and can be adjusted by an integrated Cal-function.



Attention: The device covers a wide measuring range, however an electrode suitable for the measuring range has to be used.

Range CELL - rAnG	1	2	3	4	5
0.01	0.000 - 5.000 $\mu\text{S/cm}$	0.00 - 50.00 $\mu\text{S/cm}$	0.0 - 500.0 $\mu\text{S/cm}$	0 - 5000 $\mu\text{S/cm}$	0.00 - 50.00 mS/cm
0.1	0.00 - 50.00 $\mu\text{S/cm}$	0.0 - 500.0 $\mu\text{S/cm}$	0 - 5000 $\mu\text{S/cm}$	0.00 .. 50.00 mS/cm	0.0 - 500.0 mS/cm
1	0.0 - 500.0 $\mu\text{S/cm}$	0 - 5000 $\mu\text{S/cm}$	0.00 - 50.00 mS/cm	0.0 - 500.0 mS/cm	0 - 1000 mS/cm
10	0 - 5000 $\mu\text{S/cm}$	0.00 - 50.00 mS/cm	0.0 - 500.0 mS/cm	0 - 1000 mS/cm	---

If the range selection is set to „Auto Range“, the range with the best resolution is automatically selected. However, logger operation requires a manual/fixed selection of the measuring range from the table above (No logger operation with Auto-range!).

6.4 Resistivity measurement

The resistivity is the reciprocal value of the conductivity and the device displays it in kOhm•cm (MOhm•cm).

Range CELL - rAnG	1	2	3	4
0.01	0.10 - 50.00 kOhm•cm	0.1 - 500.0 kOhm•cm	0.000 - 5.000 MOhm•cm	0.000 - 50.00 MOhm•cm
0.1	0.010 - 5.000 kOhm•cm	0.01 - 50.00 kOhm•cm	0.0 - 500.0 kOhm•cm	0.000 - 5.000 MOhm•cm
1	0.0010 - 0.5000 kOhm•cm	0.001 - 5.000 kOhm•cm	0.00 - 50.00 kOhm•cm	0.0 - 500.0 kOhm•cm
10	---	0.0001 - 0.5000 kOhm•cm	0.000 - 5.000 kOhm•cm	0.00 - 50.00 kOhm•cm

If the range selection is set to „Auto Range“, the range with the best resolution is automatically selected. However, logger operation requires a manual/fixed selection of the measuring range from the table above (No logger operation with auto-range!).

6.5 TDS measurement

At the TDS (total dissolved solids) measurement the filtrate dry residue is determined by means of the conductivity and a conversion factor (C.tdS). Well suited for easy concentration measurements of e.g. salt solutions. The determined value is displayed in mg/l.

Range CELL - rAnG	1	2	3	4
0.01	0.000 - 5.000 mg/l	0.00 - 50.00 mg/l	0.0 - 500.0 mg/l	0 - 5000 mg/l
0.1	0.00 - 50.00 mg/l	0.0 - 500.0 mg/l	0 - 5000 mg/l	---
1	0.0 - 500.0 mg/l	0 - 5000 mg/l	---	---
10	0 - 5000 mg/l	---	---	---

Displayed value TDS = conductivity [in $\mu\text{S/cm}$, nLF-temp. comp. at 25°C] • C.tdS (input at menu)

Approximately:

C.tdS	
0.50	Monovalent salts with 2 ion types (NaCl, KCl, etc.)
0.50	Natural waters / surface waters, drinking water
0.65 - 0,70	e.g. salt concentration of aqueous fertilizer solutions

Attention: This are only approximate values – good for estimations, but no precise measurement.

For precise measurements the conversion value has to be determined for the corresponding solution for the relevant concentration range.

This may be done by comparison with known reference solutions or by actually evaporating a certain amount of solution with determined conductivity and subsequent weighing of the dry residue.

6.6 Salinity measurement

At the salinity measurement "SAL" the salinity (salt content) of seawater is determined (based on: International Oceanographic Tables; IOT). Standard seawater has a salinity of 35 ‰ (35 g salt per 1 kg seawater).

Commonly the measured value is displayed dimensionless in ‰ (g/kg).

Additionally the term "PSU" (Practical Salinity Unit) is sometimes used, the displayed value is the same.

The salinity measurement has its "own" temperature compensation, i.e. the temperature is automatically taken into account for the salinity measurement. The menu settings regarding the temperature compensation are ignored.



The salt composition of the different seas is not the identical. Depending on place, weather, tides, etc. there may be considerable divergences to the 35 ‰ according to IOT. Additionally the salt composition may influence the ratio between salinity and actual salt content.

For many salts of the seawater aquaristics the corresponding tables are available (salt weight to salinity according to IOT or conductivity). Considering these tables, very precise salinity measurements can be performed (Therefore we recommend the 4-pole graphite measuring cells LF 400 or LF 425.).

6.7 Electrodes / measuring cells

6.7.1 Assignment bayonet-connector

device pin assignment

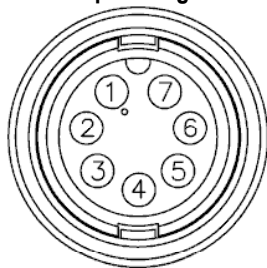

- 1: electrode I+
- 2: electrode U+
- 3: electrode U-
- 4: electrode I-
- 5: temperature sensor
- 6: temperature sensor
- 7: *not connected*

6.7.2 Design and selection

Basically there are two types of measuring cells: 2-pole and 4-pole cells. The operation is done similarly; the 4-pole measuring cells can compensate polarization effects and – up to some degree – soiling due to its complex measuring method.

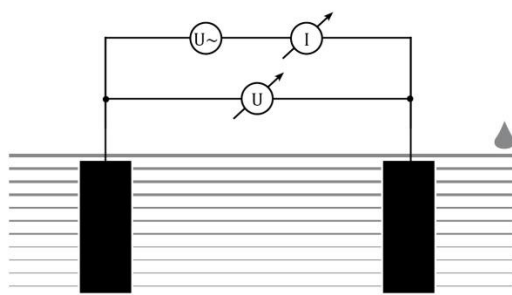

2-pole measuring cell

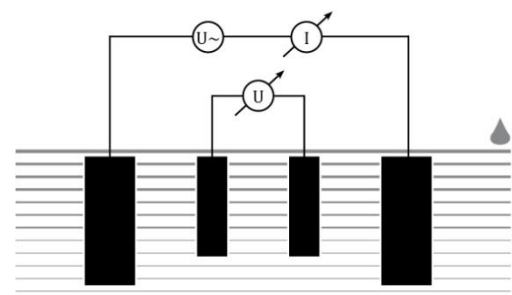

4-pole measuring cell

The selection of a suitable electrode depends on the desired application.

- The **widest range of application** is guaranteed by high-quality 4-pole graphite measuring cells (LF 400 or LF 425, all the above applications and: seawaters, titration and sewage).
- For **low conductivities (<10 $\mu\text{S}/\text{cm}$)** stainless steel measuring cells offer advantages (LF 200 RW, pure and ultrapure water, boiler water, osmosis, filter technology).
- 2-pole platinum electrodes with glass shaft are good solution for used in **petrol, diesel, etc. with low conductivities (< 1000 $\mu\text{S}/\text{cm}$)** (LF 210)

6.7.3 Calibration / Adjustment of measuring cells

Especially in harsh environments and over long time the cell constants of measuring cells are drifting. Depending on the application and use we recommend a regular checking of the precision of the measuring chain: instrument + cell. For this there are control solutions available (GKL 100, 101, 102). At normal use a checking each half year is recommended (see chapter 11 Automatic Adjustment/Calibration of Cell Constant). A system check at the manufacturer is recommended in case of doubt: see chapter 15 Accuracy Check / Adjustment Service).

6.8 Temperature compensation

The conductivity of aqueous solutions depends on its temperature. The temperature dependency is strongly dependent on the type of solution. The temperature compensation recalculates solutions' conductivity to a consistent reference temperature. The most common reference temperature is 25 °C.

6.8.1 Temperature compensation “nLF” according to EN 27888

For most applications (e.g. in the area of fish farming, surface or drinking water measurements, etc.) the non-linear temperature compensation for natural water (“nLF”, according to EN 27888) is sufficiently accurate. The common reference temperature is 25 °C.

Recommended application range of nLF-compensation: between 60 µS/cm and 1000 µS/cm.

6.8.2 Linear temperature compensation and determination of temperature coefficient “t.Lin”

If the actual function needed for exact temperature compensation is not known, “linear temperature compensation” is normally selected (Menu, t.Cor = Lin, t.Lin corresponds TK_{lin}), i.e. one assumes that the actual temperature dependency at the considered concentration range is approximately equal:

$$LF_{Tref} = \frac{LF_{Tx}}{1 + \frac{TK_{lin}}{100\%} \cdot (Tx - Tref)}$$

Temperature coefficient of about 2.0 %/K are most common.

A temperature coefficient can be determined for example by measuring a solution with deactivated temperature compensation at two different temperatures (T1 and T2).

$$TK_{lin} = \frac{(LF_{T1} - LF_{T2}) \cdot 100\%}{(T1 - T2) \cdot LF_{T1}}$$

TK_{lin} is the value input at the menu “t.Lin”.





LF_{T1} conductivity at temperature T1



LF_{T2} conductivity at temperature T2

7 Configuration



Some menu points depend on current device settings (e.g. some points are locked if logger memory contains data sets).

To change device's settings, press “**menu**”  for 2 seconds. This will activate the configuration menu (main display: “SEt”). Pressing “**menu**”  changes between the menu points, pressing  jumps to the referring parameters, which can be selected with key .

The parameter value can be changed with  or .

Pressing “**menu**”  again jumps back to the main configuration menu and saves the settings.

Pressing “**enter**”  finishes the configuration.







Pressing “menu” and “store” at the same time for more than 2 seconds will reset the device to factory defaults.

If there are data sets stored and logger is set to “manual recording” (“Func Stor”) the first menu point displayed is “rEAd Logg” (see chapter 8 “Data Logger”)

If no key is pressed for more than 2 minutes the configuration will be aborted. All changes will be discarded!

Menu	Parameter	Value	Description		
		or			
rEAd LoGg	rEAd Logg: Read manual recordings, see chapter 8.1 Manual recording ("Func-Stor")				
SEt ConF	Set Configuration: General configuration				
	InP	Input: Selection of displayed unit		**	
	Set	Choice of displayed unit via set-key Attention: Causes limitations for alarm und analog output (DAC)			
	Cond	Conductivity			
	rES	Resistivity			
	SAL	Salinity			
	tdS	Total dissolved solids			
	C.tdS	TDS measurement: conversion factor (only if Inp = tdS)			
	0.40 - 1.00	Conversion factor for TDS measurement			
	(CELL) rAng	Cell Range: Adjustment of cell constant: cell constant range			
	0.01	Ultrapure water, electrodes with K ~ 0.01			
	0.1	Ultrapure water, electrodes with K ~ 0.1			
	1	Standard electrodes, i.e. with K= 0.55 or K=1			
	10	Electrodes with K=10			
	(CELL) FACT	Cell Factor: Adjustment of cell constant: multiplication factor			
	0.4000 - 1.5000	Multiplication factor of cell constant Cell constant CELL = CELL Range * CELL Factor			
	t.InP	t-Input: Selection of temperature input type			
	ntc	NTC 10k sensor			
	Pt	Pt1000 sensor			
	rAng	Range: Selection of display range (conductivity, resistivity or tdS)			
	Auto	Automatic range selection			
	e.g. 500.0 µS/cm	Example for CELL rAng 1 and InP Cond: others in chapter 6.2			
	... 1000 mS/cm	Example for CELL rAng 1 and InP Cond: others in chapter 6.2			
	CAL	Automatic adjustment/calibration with reference solution (only if Inp = Cond)			
	Edit	Manual adjustment to reference value			
	REF.S	Choice of standard reference solutions			
	rEF.S	REF.S: Choice of standard reference solutions for automatic adjustment/cal.			
	1413 µS/cm	Reference solution 0.01 M KCL			
	2760 µS/cm	0.02 M KCL			
	12.88 mS/cm	0.1 M KCL			
	50 mS/cm	Sea-water reference solution KCL			
	111.8 mS/cm	1 M KCL			
	Unit t	Unit t: Selection of temperature unit			
	°C	All temperature values in degree Celsius			
	°F	All temperature values in degree Fahrenheit			
	t.Cor	Temperature compensation (not for InP = SAL)			
	oFF	No temperature compensation of conductivity measurement			
	nLF	Non-linear function for natural waters according to EN 27888 (ISO 7888), ground, surface and drinking water			
	NaCl	Compensation for weak NaCl-solutions (pure and ultrapure water)			
	Lin	Linear temperature compensation			
	t.Lin	Compensation coefficient (only if t.Cor = Lin)			
	0.300 3.000	Temperature compensation coefficient in %/K			
	t.rEF	Reference temperature of temperature compensation (only if t.Cor = Lin or nLF)			
	25 °C / 77 °F	Reference temperature 25 °C / 77 °F			
	20 °C / 68 °F	Reference temperature 20 °C / 68 °F			

Li nt	Adjustment/Calibration: Adjustment reminder period (factory setting: 180)			
	1 ...730	Adjustment reminder period (in days)		
	oFF	No adjustment reminder		
Auto	Auto Hold: Automatic measuring value identification (only if Logger = oFF)			
	on	Auto measuring value identification (only if Logger = oFF) Auto Hold		
	oFF	Standard hold function on key press (only if Logger = oFF)		
P.oFF	Auto Power-Off : Selection of power-off delay			
	1...120	Power-off delay in minutes. Device will be automatically switched off as soon as this time has elapsed if no key is pressed/no interface communication takes place.		
	oFF	Automatic power-off function deactivated (continuous operation)		
Li tE	Background illumination			
	oFF:	Illumination deactivated		
	5 ... 120	Turn off illumination after 5... 120s (factory settings: 10 s)		
	on:	Illumination always on		

Menu	Parameter	Value	Description		
		 Or 			
SEt Out	Set Output: Configuration of universal output				
	Out	oFF	Interface and analog output off -> minimal power consumption		
		SEr:	Serial interface activated		
		dAC:	Analog output activated		
	Adr.	01,11..91	Base address for serial interface communication		
	dAR.0	0.0000 µS/cm .. 1000 mS/cm	Measuring value that should correspond to output 0 V e.g. for 0.0000 µS/cm		
dAR.1	0.0000 µS/cm .. 1000 mS/cm	Measuring value that should correspond to output 1 V e.g. for 100.0 mS/cm			
SEt Corr	Set Corr: Measurement correction			**	
	OFFS	Zero point adjustment / offset of temperature measurement		**	
		oFF	No zero point adjustment for temperature measurement		
		-5.0 ... 5.0°C	Offset of temperature measurement in °C		
	SCAL	Slope adjustment of temperature measurement		**	
oFF		No slope adjustment for temperature measurement			
	-5.00 ... 5.00	Slope correction of temperature measurement in [%]			
SEt AL.	Set Alarm: Configuration of alarm function				
	AL. 1	On / No.So	Measuring channel cond/rES/TDS/SAL: alarm on with buzzer / without buzzer		
		OFF	No alarm function for measuring channel cond/rES/TDS/SAL		
	A.1Lo	0.0000 µS/cm .. 1000 mS/cm	Min-alarm limit for cond/rES/TDS/SAL (not if AL. 1. oFF)		
	A.1Hi	0.0000 µS/cm .. 1000 mS/cm	Max-alarm limit for cond/rES/TDS/SAL (not if AL. 1. oFF)		
	AL. 2	On / No.So	Temperature measurement: alarm on with buzzer / without buzzer		
		OFF	No alarm function for temperature measurement		
A.2Lo	-5.0 ...+100.0 °C	Min-alarm limit for temperature (not if AL. 2. oFF)			
A.2Hi	-5.0 ...+100.0 °C	Max-alarm limit for limit temperature (not if AL. 2. oFF)			
SEt LoGg	Set Logger: Configuration of logger function			**	
	Func	Selection of logger function		*	
		oFF	No logger activated		
		Stor	Store: Manual recording		
	CYCL	Cyclic: Cyclic logger			
	CYCL	0:01... 60:00	Cycle time in [minutes:seconds] (for cyclic logger)	**	
SEt CLocK	Set Clock: Setting of real time clock				
	CLocK	HH:MM	Clock: set time hours:minutes		
		YEAR	YYYY	Year: set year	

	DATE	TT.MM	Date: set date day.month		
rEAd CAL.	rEAd CAL: Read calibration data: see chapter 12.2 "Calibration memory (rEAd CAL)"				

- (*) If logger memory contains data sets parameters marked with (*) cannot be called. You have to clear memory to change these parameters!
- (**) If logger is running parameters marked with (**) cannot be called.

8 Data Logger



No logger operation possible with auto-range! The measuring range has to be selected explicitly – see chapter 7 "Configuration" – r R n b

The device supports two different logger functions:

- "**Func-Stor**": Manual recording by key press "store"
Additional input of measuring point (L-Id) is needed
- "**Func-CYCL**": Automatic recording at intervals of set cycle time

The logger stores 2 measuring values per data set.

One data set consists of:

- meas. value cond/rES/TDS/SAL (one of them)
- meas. value temperature
- measuring point L-Id (only for "**Func-Stor**")
- time and date (when data set is saved)

For the evaluation of the data the software GSOFT3050 (version V3.0 or higher) has to be used. The software also allows easy configuration and starting of the logger.

When the logger is activated (Func Stor or Func CYCL) the hold function is no more available, the key "store" is solely used for the operation of the logger functions.



8.1 Manual recording ("Func-Stor")

a) Save measurements manually:

Up to 1000 measurements can be saved if logger function "Func store" is selected. (see "Configuration"):



Press "store" shortly: data set is saved ("St. XX" is displayed shortly, where XX is the number of the data set)

Input of the measuring point "L-Id": Selection of measuring point via keys  or .
Number 0...19999 or text assigned to number 1...40
(comfortable assignment of texts can be done with gratis software GMHKonfig)

Confirm input with .

If logger memory is full, the following is displayed: **L066**
FULL

b) Read manual recordings:

Saved data sets can be viewed both with PC-software GSOF3050 and directly on the device display.



Press “menu” for 2 seconds: $rEAd$
LoGg is displayed



“rEAd LoGg” is only displayed if data sets have been already stored! Otherwise the configuration menu is displayed: SEt
LoGg



Press shortly: Change between measuring values, measuring point and date+time of the currently selected data set



or



Change between different data sets



Quit display of recordings

c) Clear manual recordings:

If data sets have been stored, they can be deleted with the “store” key:



Press “store” for 2 seconds: Call menu “Clear”

Select with: or .

CLr
no

Clear nothing (cancel)

CLr
ALL

Clear all data sets

CLr
LAST

Clear the latest data set



Confirm selection and quit menu “Clear”

8.2 Automatic recording with selectable cycle time “Func CYCL”

If logger function “Func CYCL” is selected (see “Configuration”) the device will automatically record measuring values at intervals of the set cycle time.

The logger’s cycle time can be set from 1s to 60min (see “Configuration”).

Up to 10000 measurements can be saved if logger function “Func CYCL” is selected.

a) Start recording:

Press “store” for 2 seconds: Start menu, press again: automatic recording is started

Each logging process is signaled by shortly displaying “St.XXXXX”, where XXXXX is the number of the saved data set.

If the logger memory is full, the recording stops automatically and the display shows $LoGg$
FULL.

b) Stop recording:

Press “store” for 2 seconds: If recording is running the “stop” menu is displayed

Select with or .

Do not stop recording (cancel)

Stop recording



If recording is running the “stop” menu is displayed



If you try to switch off the device while cyclic recording is active you will be asked whether the recording should really be stopped.

The device can only be switched off if the recording is stopped. Auto-off function is deactivated as long as cyclic recording is active.

c) Clear recordings:

Press “store” for 2 seconds:

If there are data sets stored and recording is already stopped the menu “Clear” is displayed

Select with or .

Clear nothing (cancel)

Clear all data sets

Clear latest data set



Confirm selection and quit menu “Clear”

9 Universal Output

The output can be used either as serial interface (for USB 5100 interface converter) or as analog output (0-1V). If the output is not needed, it is strongly recommended to deactivate it (Out oFF) to lower power consumption. This increases battery life time.

If the device is used together with interface adapter USB 5100 the device is supplied from the interface.

device pin assignment:



1: external supply +5V, 50mA

2: GND

3: TxD/RxD (3.3V Logic)

4: +U_{DAC}, analog output



Only suitable adaptor cables are permitted (accessories)!



When operating with external supply or connected interface and measurement at solutions with earth connection, there may appear distortions or deviations of the measuring. In case of doubt disconnect supply/interface.

The same is valid for the analogue output: Depending how the output is connected (e.g. even without isolation), in case of doubt do not measure in solutions with earth contact.

9.1 Interface

The following standard software packages are available:

- **GSOFT3050:** Operating and evaluation software for the integrated logger function
- **EBS20M / -60M:** 20-/60-channel software for measuring value display
- **GMHKonfig:** Configuration Software (for free on internet)

In case you want to develop your own software we offer a **GMH3000-development package** including:

- a universally applicable Windows functions library ('GMH3000.DLL') with documentation, can be used by all 'established' programming languages, suitable for:
Windows XP™, Windows Vista™, Windows 7™, Windows 8 / 8.1™, Windows 10™
- Programming examples Visual Studio 2010 (C#, C++ and VB), Testpoint™, LabView™ etc.

The device has 2 channels:

- Channel 1: current measuring value (Cond, rES, TDS or SAL) and base address
- channel 2: temperature value



The measuring-/ alarm- and display range values read back from the interface are always in the selected measurement unit!



ATTENTION

When using the interface, the auto-range-function should be turned off. If auto-range is activated, the returned value are based on the resolution of the smallest range, there may be returned extreme values like 123400.0 µS/cm instead 123.4 mS/cm.

9.2 Analog output

An analog voltage 0-1V can be tapped at the universal output socket (mode: "Out dAC"). The analog output can be easily scaled with DAC.0 and DAC.1.

Please take care not to load the analog output too heavily, otherwise the output value will be distorted and the power consumption will rise. Loads up to approx. 10 kOhm are unproblematic.

If the displayed value goes beyond DAC.1 the output voltage will be 1V.

If the displayed value falls below DAC.0 the output voltage will be 0V.

In error case (Err.1, Err.2, ----, etc.) the output voltage will be slightly higher than 1V.



ATTENTION

We suggest to choose a fixed unit for the display (e.g. "lnP cond") when using the analog output.

If „lnP 5Et“ is chosen instead, this may lead to unpredictable behaviour of the output.

10 Adjustment of Temperature Input

The temperature input can be adjusted with offset and scale. A reasonable adjustment presumes reliable references (e.g. ice water, controlled precision water bath, etc.).

If the inputs are adjusted (i.e. offset and scale are different from default settings) the device will shortly display "Corr" after turned on.

Default setting for offset and scale are 'off' = 0.0, i.e. inputs are not changed.

Zero point correction: **$Displayed\ value = measured\ value - OFFS$**

Zero point and slope correction: **$Displayed\ value = (measured\ value - OFFS) * (1 + SCAL / 100)$**
 $Displayed\ value\ ^\circ F = (meas.\ value\ ^\circ F - 32^\circ F - OFFS) * (1 + SCAL / 100)$

11 Automatic Adjustment/Calibration of Cell Constant

Besides the direct input of the cell constant (see below) via the menu ("CELL FACT") the cell constant can also be determined automatically (Please select CELL rAnG in menu before):

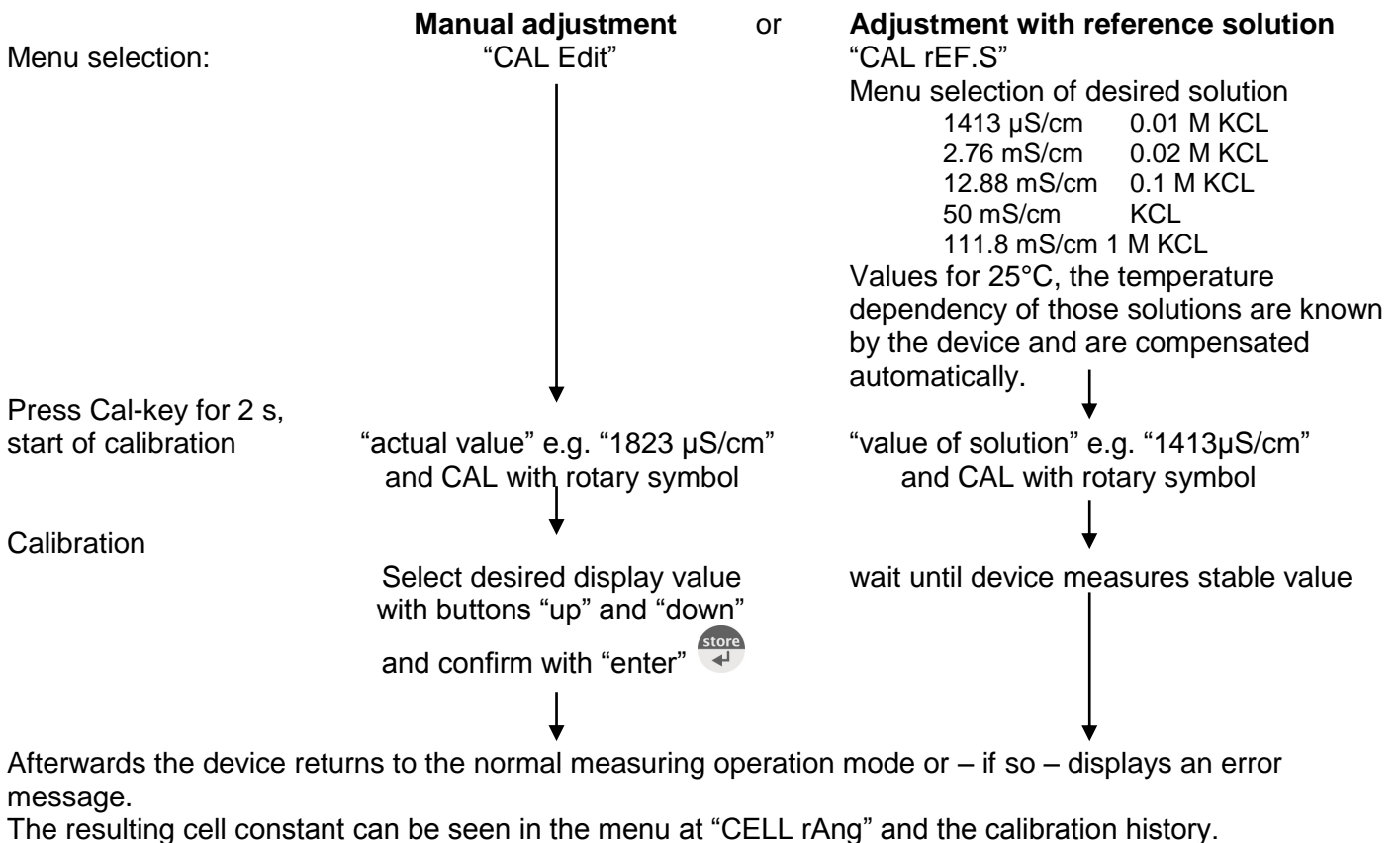

Error messages of automatic adjustment/calibration:

CAL Err.1	Cell constant too high	Determined cell constant must not exceed 1.5 * cell range
CAL Err.2	Cell constant too small	Determined cell constant must not fall below 0.4 * cell range
CAL Err.3	Solution of wrong range	Wrong cell range / wrong solution / far beyond tolerance
CAL Err.4	Wrong temperature	Beyond permitted temperature: 0.0 – 34.0 °C (or 0.0 – 27.0 °C at 111.8 mS/cm)

Alternative to automatic adjustment:

Manual calculation of cell constant with a reference solution

Example KCl-solution $c = 0.01$ M: $1413 \mu\text{S cm}^{-1}$ at 25°C

At other temperatures switch temperature compensation off (t.Cor = OFF) and use the referring conductivity!

Conductivity_{displayed} = $1900 \mu\text{S cm}^{-1}$ if selected cell constant is 1.000 cm^{-1} (CELL FACT = 1.000)

Conductivity of solution at solution temperature 25°C : Conductivity_{real} = $1413 \mu\text{S cm}^{-1}$

Cell constant $k = \text{conductivity}_{\text{real}} / \text{conductivity}_{\text{displayed}} [\text{cm}^{-1}]$
 $= 1413 / 1970 * \text{cm}^{-1} = \mathbf{0.7437 \text{ cm}^{-1}}$ (Enter CELL FACT of 0.7437)

12 GLP

GLP (Good Laboratory Practice) includes regular check of devices and accessories. For pH measurements it is highly important to ensure correct pH calibration. The device provides the following functions to help with this.

GLP (Good Laboratory Practice) includes regular check of devices and accessories. For pH measurements it is highly important to ensure correct pH calibration. The device provides the following functions to help with this.

12.1 Calibration interval (C.Int)

You can input the interval after which the device reminds you to recalibrate.

The interval times should be chosen according to the application and the stability of the electrode. "CAL" flashes on the display as soon as the interval has expired.

12.2 Calibration Memory (rEAd CAL)

The last 16 calibrations are stored with results and date and can be read out.

Display calibration data:

Historical calibration data can be comfortably read out via PC software GMHKonfig and GSOF3050 or displayed directly at the device:



Press for 2 seconds:

The display will show:

rEAd LoBB or SEt Conf (configuration level)



Press several times until this is displayed:

rEAd CAL. read cal. = "read calibration data"

Press shortly: switch between:

- CELL = cell constant
- C.rEF = reference value, at which cell constant has been adjusted
- Display of date+time of data set



or



Change between the different calibration data sets



Quit calibration data set display

13 Alarm ("AL.")

There are 3 possible settings:

off (AL.oFF), on with buzzer (AL.on), on without buzzer (AL.no.So).

Alarm is given in the following cases (if alarm active, AL.on or AL.no.So):

- Lower alarm boundary (AL. Lo) under-run
- Upper alarm boundary (AL. Hi) over-rum
- Sensor error
- Low battery (bAt)
- Err.7: system error (always with buzzer!)

In case of an alarm (and when polling the interface) the 'PRIO'-flag is set in the returned interface message.



We suggest to choose a fixed unit for the display (e.g. "lnP cond") when using the alarm function.

ATTENTION

If „lnP SEt“ is chosen instead, this may lead to unpredictable behaviour of the alarm.

14 Real Time Clock ("CLOC")

The real time clock is used for chronological assignment of the logger data and calibration points. Please check the settings when necessary.

15 Accuracy Check / Adjustment Service

You can send the device to the manufacturer for adjustment and inspection.

Calibration certificate - DKD certificate - official certifications:

If the measuring instrument is supposed to receive a calibration certificate, it has to be sent to the manufacturer (declare test points).

If the device is certificated together with a suitable sensor very high overall accuracies are possible.

Basic settings can only be checked and – if necessary – corrected by the manufacturer.

A calibration protocol is enclosed to the device ex works. This documents the precision reached by the production process.

16 Replacing Batteries

Before changing batteries, please read the following instruction and follow it step by step.

Not following the instruction may cause harm to the instrument or the protection against ingress of water and dust may be lost!

Avoid unnecessary opening of the instrument!

1. Open the 3 Phillips screws at the backside of the instrument.
2. Lay down the still closed instrument, so that the display side points upwards.
The lower half of the housing incl. the electronics should be kept lying down during battery change.
This avoids loss of the 3 sealing rings placed in the screw holes.
3. Lift off upper half of housing. Keep an eye on the six function keys, to be sure not to damage them.
4. Change carefully the two batteries (Type: AAA).
5. Check: Are the 3 sealing rings placed in the housing?
Is the circumference seal of the upper half sound and clean?
6. Close the housing, taking care that it is positioned correctly, otherwise the sealing may be damaged. Afterwards press the two halves together, lay the instrument with display pointing downwards and screw it together again

Take care to screw only until you feel increasing resistance, higher screwing force does not result in higher water protection!

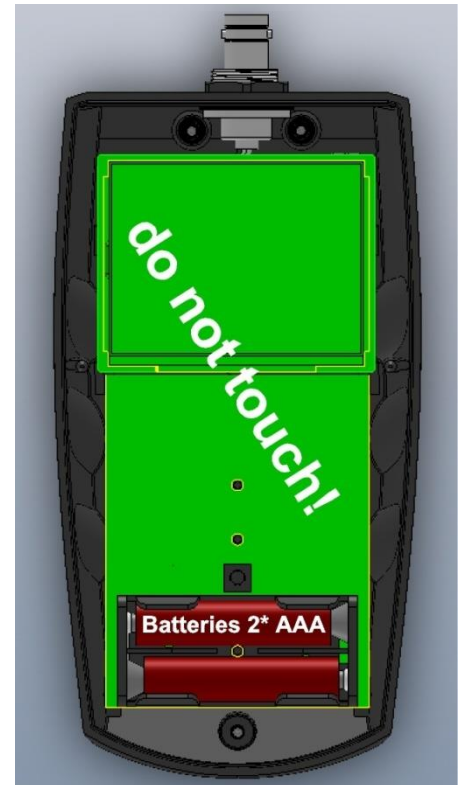

17 Error and System Messages

Error messages for measurement

	Description	What to do?
No display or confused characters, Device does not react on key press	Battery empty	Replace battery
	Mains operation: wrong voltage or polarity	Check power supply, replace it if necessary
	System error	Disconnect battery and power supply, wait shortly, then reconnect
	Device defective	Return to manufacturer for repair
Err.1	Measured value above allowable range	Check: pressure not within sensor range? -> measuring value to high!
	Sensor defective	Return to manufacturer for repair
Err.2	Measured value below allowable range	Check: pressure not within sensor range? -> measuring value to low!
	Sensor defective	Return to manufacturer for repair
Err.7	System error	Return to manufacturer for repair
	Value extremely out of measuring range	Value extremely out of measuring range
----	Could not calculate display value	
	• measuring range or input range exceeded	Check range parameter
	• measured values are instable	Wait for signal regulation of the device
> CAL < CAL flashing in upper display	Either preset calibration interval has expired or last calibration is not valid	Device has to be calibrated!
no Auto Lo55 rAn5	Logger could not be started	Auto range for the display range is active => change the parameter in the configuration menu

Error messages for automatic cell constant adjustment/calibration:

CAL Err.1	Cell constant too high	Determined cell constant must not exceed 1.5* cell range
CAL Err.2	Cell constant too small	Determined cell constant must not fall below 0.4* cell range
CAL Err.3	Solution of wrong range	Wrong cell range / wrong solution / far beyond tolerance
CAL Err.4	Wrong temperature	Beyond permitted temperature: 0.0 – 34.0 °C (or 0.0 – 27.0 °C at 111.8 mS/cm)

If “bAt” is flashing the battery will be exhausted soon. Further measurements are possible for short time. If “bAt” is displayed continuously the battery is ultimately exhausted and has to be replaced. Further measurements aren't possible any more.

18 Reshipment and Disposal

18.1 Reshipment



All devices returned to the manufacturer have to be free of any residual of measuring media and other hazardous substances. Measuring residuals at housing or sensor may be a risk for persons or environment



Use an adequate transport package for reshipment, especially for fully functional devices. Please make sure that the device is protected in the package by enough packing materials.

18.2 Disposal instructions



Batteries must not be disposed in the regular domestic waste but at the designated collecting points.

The device must not be disposed in the unsorted municipal waste! Send the device directly to us (sufficiently stamped), if it should be disposed. We will dispose the device appropriate and environmentally sound.

19 Specification

Measuring ranges	count	5		
		Cell constant 0.4 ... 1.5	Cell constant 0.04 ... 0.15	Cell constant 0.004 ... 0.015
	Conductivity 1 *)	0.0 ... 500.0 µS/cm	0.00 ... 50.00 µS/cm	0.000 ... 5.000 µS/cm
	" 2 *)	0 ... 5000 µS/cm	0.0 ... 500.0 µS/cm	0.00 ... 50.00 µS/cm
	" 3 *)	0.00 ... 50.00 mS/cm	0 ... 5000 µS/cm	0.0 ... 500.0 µS/cm
	" 4 *)	0.0 ... 500.0 mS/cm	0.00 ... 50.00 mS/cm	---
" 5 *)	0 ... 1000 mS/cm	---	---	
Resistivity	0.0010 ... 500.0 kOhm*cm	0.010 ... 5000 kOhm*cm	0.0001 ... 50.00 MOhm*cm	
TDS	0.0 ... 5000 mg/l	0.00 ... 5000 mg/l	0.000 ... 5000 mg/l	
Salinity	0.0 ... 70.0 g/kg (PSU)			
Temperature	-5.0 ... +100.0 °C, Pt1000 or NTC (10k) 23.0 ... 212.0 °F			
Supported cell constants	4.000 ... 15.000 / cm; 0.4000 ... 1.5000 / cm; 0.04000 ... 0.15000 / cm; 0.004000 ... 0.015000 / cm			
Accuracy	Conductivity	±0.5% of m.v. ±0.1 % FS (system accuracy is dependent on electrode!)		
	Temperature	±0.2 K		
Connections	Conductivity, Temperature	7-pole bayonet socket for connection of different measuring cells Supported temperature sensors Pt1000 and NTC 10k		
	Interface / ext. supply	4-pole bayonet socket for serial interface and supply (USB Adapter USB 5100) Analog output 0-1V, adjustable		
Display	4 ½ - digit, 7-segment, illuminated (white)			
Add. functions	Min / max / hold function			
Adjustment/ Calibration	Cell constant manually or automatically via selectable reference solution			
GLP	Selectable adjustment intervals (1 to 730 days, CAL-warning after expiration) Memory: latest 16 adjustments			
Data logger	Real-time clock Cyclic: 10000 data sets, cycle time selectable: 1s ... 60 min Single: 1000 data sets (with measuring point input, 40 selectable measuring point texts or numbers)			
Alarm	2 alarm channels with separate limit values for conductivity (or resistivity, TDS, SAL) and temperature Alerting: buzzer / visual / interface			

Housing		Break-proof ABS housing, incl. silicone protective cover
	Protection class	IP65 / IP67
	Dimensions L*W*H [mm]	160 * 86 * 37 incl. silicone protective cover, approx. 250 g incl. battery and cover
Working conditions		-25 to 50 °C; 0 to 95 % RH (non condensing)
Storage temperature		-25 to 70 °C
Power supply		2*AAA battery (included in scope of supply) or external
	Current consumption	6.25 mA (for Out = oFF, equivalent to 160 h), backlight ~10mA (auto-off)
	Battery indicator	4-stage battery state indicator, Change battery display for exhausted battery: "bAt", warning: "bAt" flashing
Auto-off function		Device will be automatically switched off if no key is pressed/no interface communication takes place for the time of the power-off delay. The power-off delay can be set to values between 1 and 120 min.; it can be completely deactivated.
Directives and standards		The instruments confirm to following European Directives: 2014/30/EU EMC Directive 2011/65/EU RoHS Applied harmonized standards: EN 61326-1 : 2013 emissions level: class B emi immunity according to table 3 and A.1 Additional fault: <1%

*) choice of electrode may limit the operational range, although a larger theoretical range is available from the instrument's side. Please refer to chapter 6.7