

Operator's Manual



This document contains proprietary information which is protected by copyright. No part of this document may be photocopied, reproduced, or translated to another language without the prior written consent of In-Situ

Mailing and Shipping Address:	Phone:	970-498-1500 (international & domestic)
In-Situ	Fax:	970-498-1598
221 East Lincoln Avenue Fort Collins, CO 80524 U.S.A.		
	Internet:	www.in-situ.com
	Support:	800-446-7488 (U.S.A. & Canada)

In-Situ makes no warranty of any kind with regard to this material, including, but not limited to, its fitness for a particular application. In-Situ will not be liable for errors contained herein or for incidental or consequential damages in connection with the furnishing, performance, or use of this material.

In no event shall In-Situ Inc. be liable for any claim for direct, incidental, or consequential damages arising out of, or in connection with, the sale, manufacture, delivery, or use of any product.

In-Situ and the In-Situ logo, Win-Situ, TROLL, Baro Merge, BaroTROLL, HERMIT, HydroVu™, iSitu, Pocket-Situ, RDO, RuggedCable, RuggedReader, SmarTROLL™, TROLL, VuSitu™, and Win-Situ are trademarks or registered trademarks of In-Situ Inc. Microsoft and Windows are registered trademarks of Microsoft Corporation. Pentium is a registered trademark of Intel. Tefzel and Delrin are registered trademarks of E. I. DuPont de Nemours and Company. Viton is a registered trademark of DuPont Dow Elastomers. Kellems is a registered trademark of Hubbell Inc. Alconox is a registered trademark of Alconox Company. Lime-A-Way is a registered trademark of Reckitt Benckiser. Android is a trademark of Google Inc. iPod and iPhone are trademarks of Apple Inc., registered in the U.S. and other countries. The Bluetooth word mark and logos are registered trademarks owned by the Bluetooth SIG, Inc. and any use of such marks by In-Situ Inc. is under license. NIST is a registered trademark of the National Institute of Standards and Technology, U.S.A. Other brand names and trademarks are property of their respective owners.



The presence of the Waste Electrical and Electronic Equipment (WEEE) marking on the product indicates that the device is not to be disposed via the municipal waste collection system of any member state of the European Union.



For products under the requirement of WEEE directive, please contact your distributor or local In-Situ office for the proper decontamination information and take back program, which will facilitate the proper collection, treatment, recovery, recycling, and safe disposal of the device.

Contents

Introduction	6
Scope	6
Serial Number Location	6
Safety	6
Electrical Safety.....	6
General Specifications	7
Sensor Specifications	8
Level, Depth, Pressure Sensor Specifications.....	8
Conductivity Sensor Specifications	8
RDO (Optical Dissolved Oxygen Sensor) Specifications	9
ORP Sensor Specifications	9
pH Sensor Specifications.....	10
Temperature Sensor Specifications (Probe)	10
Instrument Overview	11
Instrument Description.....	11
System Components.....	11
Probe Dimensions with Restrictor On	12
Probe Dimensions with Restrictor Off	12
Sensors.....	13
Cable.....	13
VuSitu Mobile App.....	13
Win-Situ 5 Software.....	13
Probe Setup	14
Installing the Sensors	15
About VuSitu	16
Connected Instrument Screen	16
VuSitu Menu Options	17
Live Readings in VuSitu	17
Snapshot Mode.....	17
Sharing Data	18
Viewing Data on a Mac or PC.....	18
Live Readings Mode.....	18
VuSitu Data	18
Selecting with Long-press and Swipe	19

VuSitu Locations	19
About VuSitu Locations	19
How to Create a Location	19
How to Select a Location	20
How to Edit or Delete a Location	20
Calibrating Sensors in VuSitu	21
Calibrating the pH Sensor	21
Calibrate the Rugged Dissolved Oxygen Sensor (1-Point)	22
100% Water-saturated Air Calibration	22
Calibrate the Rugged Dissolved Oxygen Sensor (2-Point)	22
100% Water-saturated Air Calibration	22
0-point Calibration	22
Calibrating the Rugged Dissolved Oxygen Sensor Using Concentration	23
RDO Salinity Setting	23
Communication Settings	24
Connect the Instrument to the Computer	24
Connect the Instrument to Win-Situ 5 Software	24
Win-Situ Software	25
Data Tab	25
Set Communication Outputs	26
SDI-12 Setup	28
View and Record Data	29
Calibrate and Set Up Sensors	31
Calibration Frequency Recommendations	31
Factory Calibration	32
Set Parameter Units and Sentinel Values	33
RDO Sensor Calibration	34
Calibration 100% Oxygen Saturation	34
Calibrate 0% Oxygen Saturation	35
Conductivity Calibration	37
Pressure/Level	38
Pressure/Level	38
Controller Requirements and Connections	41
Wiring Overview	41
Power Connections	41
SDI-12 Wiring Diagram	42
Configure SDI-12 Settings in VuSitu	42

Modbus Master RS485 Wiring Diagram	43
Modbus Master RS232 Wiring Diagram (Converter Required)	44
RS485 Network Guidelines	45
DB-9 Diagram	45
Communication Overview.....	45
Sensor Health Table.....	46
Care and Maintenance	47
Maintenance Schedule	47
User-Serviceable Parts.....	47
O-rings	47
RDO Sensor Cap Replacement.....	47
pH/ORP Sensor Replacement	47
Instrument Storage	47
Cleaning the pH/ORP Sensor	48
Cleaning the RDO Sensor.....	48
Cleaning the Conductivity Sensor	49
Declaration of Conformity	50

Introduction

This manual is intended to describe the characteristics, operation, calibration, and maintenance of the Aqua TROLL 400 Instrument. Communication registers and programming information can be found in the Modbus and SDI-12 Reference Guide.

Scope

This manual covers the following information.

Chapter 1—Introduction

Chapter 2—Safety

Chapter 3—General Specifications

Chapter 4—Sensor Specifications

Chapter 5—Instrument Overview

Chapter 6—System Components

Chapter 7—Probe Setup

Chapter 8—Communication Settings and Sensor Calibration

Chapter 9—Controller Requirements and Connections

Chapter 10—Care and Maintenance

Chapter 11—Declaration of Conformity

Modbus registers and SDI-12 programming information can be found in the Modbus and SDI-12 Reference Guide.

Serial Number Location

The serial number is located on the large label on the instrument body. The serial number is programmed into the instrument and displayed in the control software.

Safety

Electrical Safety

Electrical installation must be performed by properly trained and qualified personnel.

After the stripped-and-tinned cable has been properly wired to the controller, the user can safely connect the instrument to the cable using the twist-lock connector.

General Specifications

Operating temperature	-5 to 50° C (23 to 122° F)
Storage temperature	-40 to 65° C (-40 to 149° F)
Dimensions	4.7 cm (1.85 in.) OD x 26.9 cm (10.6 in.) with restrictor installed (does not include connector)
Weight	694 g (1.53 lbs)
Wetted materials	PVC, 316 stainless steel, titanium, Acetal, Viton®, PC/PMMA
Environmental rating	IP68 with all sensors and cable attached. IP67 with sensors removed and cable detached.
Reading rate	1 reading every 5 seconds (no internal logging)
Power	Required: 8–36 VDC (no internal battery). Measurement current: 16 mA @ 24 VDC. Sleep current: 40 µA @ 24 VDC
Interface	In-Situ Con TROLL® PRO System; In-Situ TROLL® Link Telemetry 101 or 201 System; SCADA/PLC; and third-party data loggers, samplers, controllers, and telemetry systems.
Cable	Customizable, non-vented (absolute) RuggedCable® System is available in either Tefzel® or polyurethane.
Warranty	2 years
Notes	Specifications are subject to change without notice. Viton is a registered trademark of DuPont Performance Elastomers L.L.C.

Sensor Specifications

Level, Depth, Pressure Sensor Specifications

Accuracy	Typical $\pm 0.1\%$ FS @ 15° C; $\pm 0.3\%$ FS max. from 0 to 50° C
Range	76 m (250 ft); absolute (non-vented)
Resolution	$\pm 0.01\%$ FS or better
Sensor Type	Fixed
Response Time	Instantaneous in thermal equilibrium
Units of Measure	Pressure: psi, kPa, bar, mbar, mmHg, inHg Level: mm, cm, m, in, ft
Methodology	Piezoresistive; ceramic

Conductivity Sensor Specifications

Accuracy	Typical $\pm 0.5\% + 1 \mu\text{S/cm}$; $\pm 1\%$ max.
Range	5 to 100,000 $\mu\text{S/cm}$
Resolution	0.1 $\mu\text{S/cm}$
Sensor Type	Fixed
Response Time	Instantaneous in thermal equilibrium
Units of Measure	Actual conductivity ($\mu\text{S/cm}$, mS/cm) Specific conductivity ($\mu\text{S/cm}$, mS/cm) Salinity (PSU) Total dissolved solids (ppt, ppm) Resistivity (Ohms-cm) Density (g/cm^3)
Methodology	Std. Methods 2510 EPA 120.1

RDO (Optical Dissolved Oxygen Sensor) Specifications

Accuracy	±0.1 mg/L from 0 to 20 mg/L ±2% of reading from 20-60 mg/L
Range	0-60 mg/L
Resolution	0.01 mg/L
Sensor Type	Fixed with replaceable RDO Sensor Cap (life: 1 year typical)
Response Time	RDO X-Cap: T63<15 sec, T90<45 sec, T95<60 sec RDO Fast Cap: T63<3 sec, T90<30 sec, T95<45 sec
Units of Measure	mg/L, % saturation, ppm
Methodology	EPA-approved In-Situ Methods 1002-8-2009 1003-8-2009 1004-8-2009

ORP Sensor Specifications

Accuracy	±5.0 mV
Range	±1400 mV
Resolution	0.1 mV
Sensor Type	Replaceable pH/ORP combo sensor
Response Time	<15 sec.
Units of Measure	mV
Methodology	Std. Methods 2580

pH Sensor Specifications

Accuracy	±0.1 pH unit from 0 to 12 pH units
Range	0 to 14 pH units
Resolution	0.01 pH unit
Sensor Type	Replaceable pH/ORP combo sensor
Response Time	<15 sec., pH 7 to pH 4
Units of Measure	pH units
Methodology	Std. Methods 4500-H+ EPA 150.2

Temperature Sensor Specifications (Probe)

Accuracy	±0.1° C
Range	-5 to 50° C (23 to 122° F)
Resolution	0.01° C or better
Sensor Type	Fixed
Response Time	T90<120 sec
Units of Measure	Celsius, Fahrenheit
Methodology	EPA 170.1

Instrument Overview

Instrument Description

The Aqua TROLL 400 Instrument is a multiparameter water quality probe. The dissolved oxygen, conductivity, pressure, and temperature sensors are integrated into the instrument. The pH/ORP sensor and the RDO Sensor Cap are replaceable.

The instrument is intended for use with a PLC/SCADA system or other data-logging device. It does not include internal power or an internal data logger. The instrument provides Modbus RS485 and SDI-12 interfaces for use with an external controller.

System Components

The system includes the following components.

- Integrated sensors: RDO, conductivity, pressure, and temperature
- Plug-in pH/ORP sensor
- Classic Cap, Fast Cap, or RDO-X Sensor Cap. The Fast Cap ships with the instrument.
- Stainless steel restrictor
- Calibration and storage cup and cable

Accessories purchased separately

- Replacement RDO Sensor Cap
- Replacement pH/ORP sensor
- Calibration Kit (includes calibration cup, 3 sponge wafers, vented cap, and storage cap)
- Stripped-and-tinned cable—length customizable
- Maintenance kit
- Comm Kit

Probe Dimensions with Restrictor On

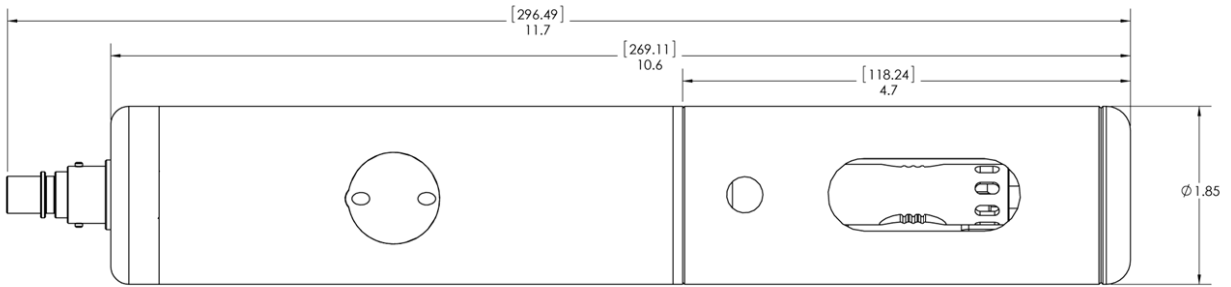

Total length with connector	296.49 mm (11.7 in.)
Total length without connector	269.11 mm (10.6 in.)
Restrictor length	118.24 mm (4.7 in.)
Diameter	47 mm (1.85 in.)

Probe Dimensions with Restrictor Off

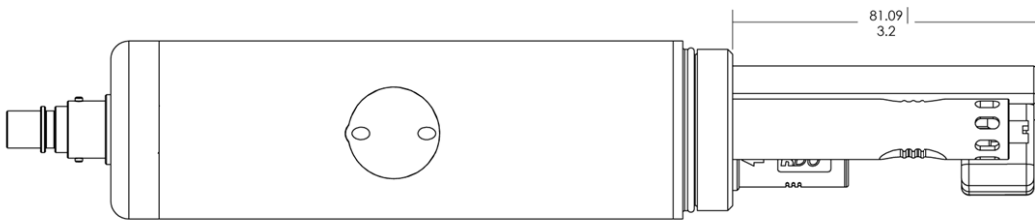

Sensor length	81.09 mm (3.2 in.)
---------------	--------------------

Sensors

Sensors include optical RDO (Rugged Dissolved Oxygen), pH/ORP, conductivity, pressure, and temperature.

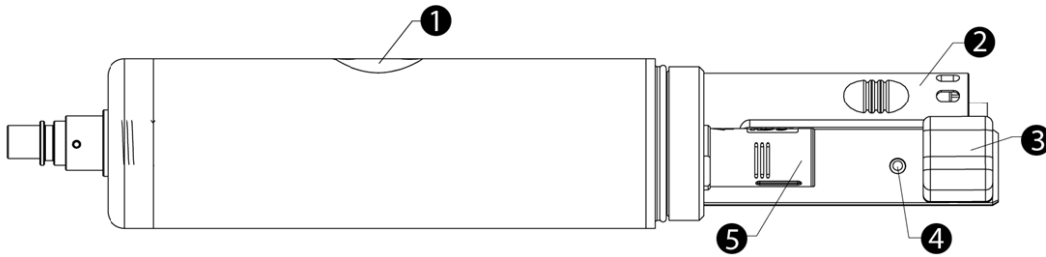

1	Pressure sensor 76 m (250 ft)
2	pH/ORP sensor
3	Conductivity sensor
4	Temperature sensor
5	RDO Sensor

Cable

The cable includes a twist-lock connection to the instrument and a stripped-and-tinned termination that must be wired to a controller. Cable length is customizable. Maximum length is 1,219 m (4,000 ft) for Modbus output, and 60.9 m (200 ft) for SDI-12 output.

VuSitu Mobile App

The VuSitu Mobile App is used with an Android or iOS device to calibrate the sensors and to configure the instrument settings to communicate with a process controller or data logger. See the Communication Settings and Calibration section for more details.

Win-Situ 5 Software

Win-Situ 5 Software is used on a desktop computer to calibrate the sensors and to configure the instrument settings to communicate with a process controller or data logger. See the Communication Settings and Calibration section for more details.

Probe Setup

The probe is shipped with a storage plug and protective dust caps in place.



1	Dust cap protector on the RDO Sensor. (Install the RDO Cap before deploying the instrument.)
2	pH/ORP storage plug. (Remove the storage plug and install the pH/ORP sensor before deploying the instrument.)
3	Dust cap protector on the twist-lock cable connector.

Installing the Sensors



Twist the restrictor off of the probe.



Locate the RDO Sensor Cap container and remove the cap.



Remove the dust cap from the RDO sensor.



Align the slotted edge of the RDO cap with the flat edge of the RDO sensor. Press the cap firmly into position.



Remove the orange plug from the pH/ORP sensor port.



Use the alignment marks to properly align the pH/ORP sensor with the port connection, and press firmly into place. Push until the sensor is completely inserted into the port.



Twist the restrictor back onto the probe.



Important: Avoid touching the sensor lens and the sensing material on the top of the cap.



Important: The RDO Sensor Cap and pH/ORP sensor must be installed firmly in place to prevent water from entering the instrument.

About VuSitu

VuSitu is the mobile user interface and control application for In-Situ water quality instruments. You can use VuSitu on mobile devices with Android operating system 4.4, Bluetooth 2.0 and newer. Download the latest version of the app from the Google Play Store at play.google.com.

VuSitu allows you to accomplish the following tasks:

- View live readings that update every 10 seconds
- Change parameters and units
- Set up a data log
- Record data
- Email data in spreadsheet format
- Download data to mobile device
- Transfer data from mobile device to a computer
- Organize data by Location
- Calibrate Sensors and View Reports

Connected Instrument Screen

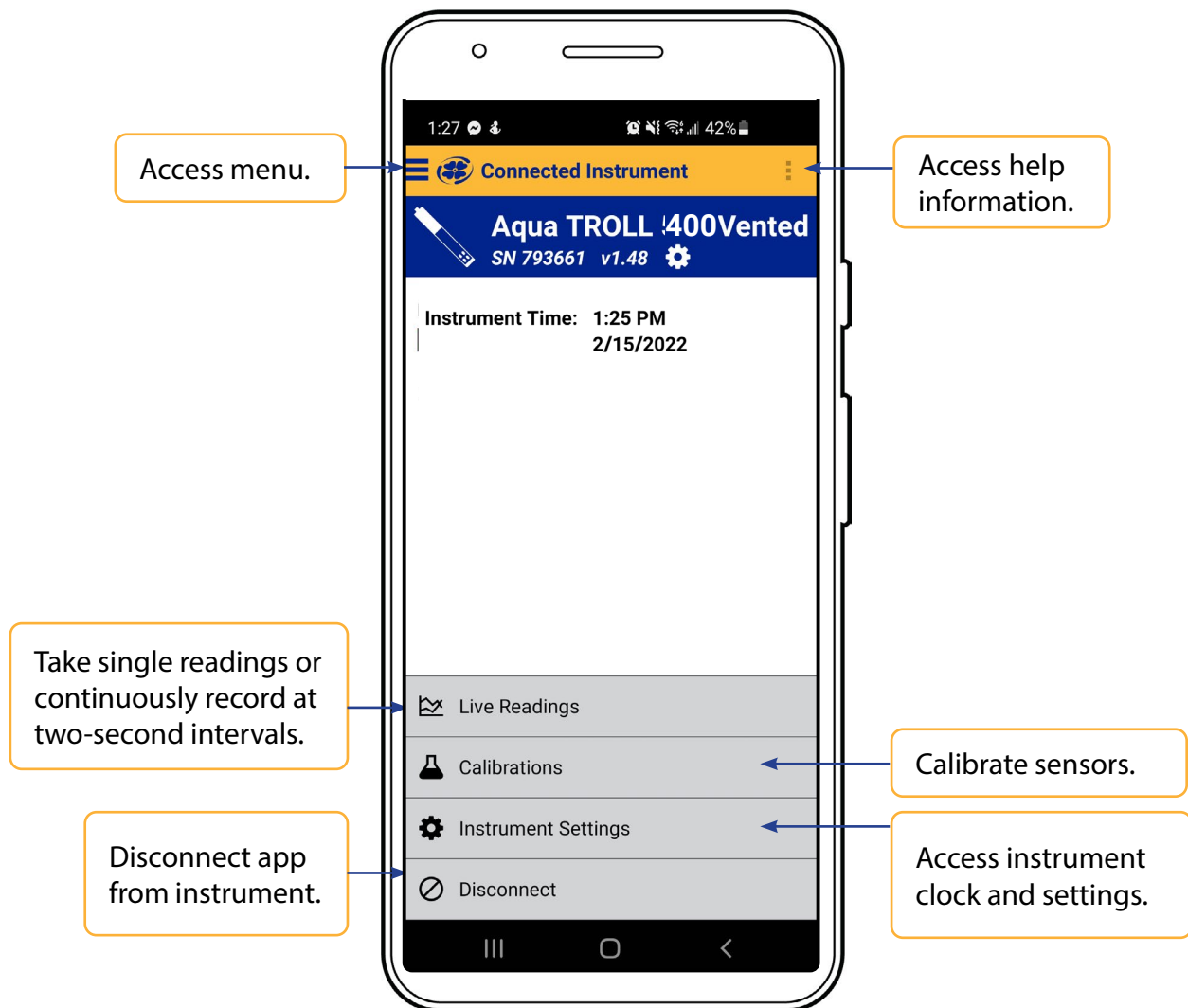

VuSitu Menu Options



The features available in the VuSitu mobile app vary slightly depending on the instrument to which it is connected.

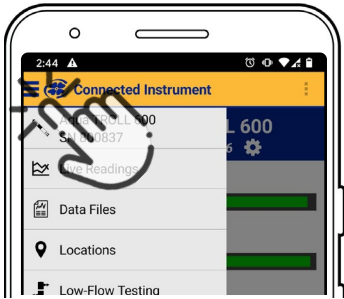

Tap the menu icon in the upper left portion of the screen to view options.

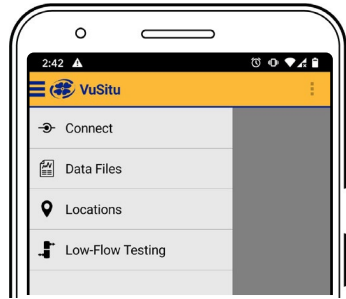

Some features aren't available when VuSitu isn't connected to an instrument.

Live Readings in VuSitu



The live readings screen displays measurements taken from the instrument every two seconds. You can save these readings and share them via email or cloud storage.

Snapshot Mode

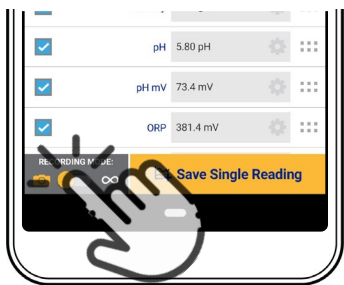

Tap the button on the bottom left to toggle between snapshot and live readings modes.



Tap **Change Location** in the top right corner to associate this data with a different location.

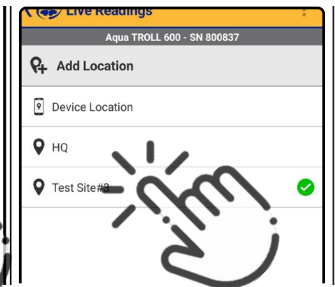

Choose the desired location and press **Save** in the bottom right corner of the screen.



Tap **Save Single Reading** to create a snapshot.

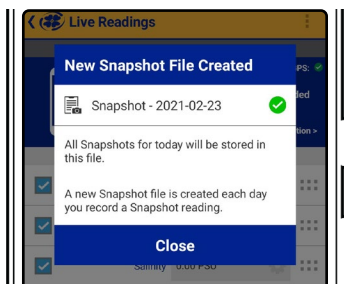

VuSitu confirms the new snapshot file.

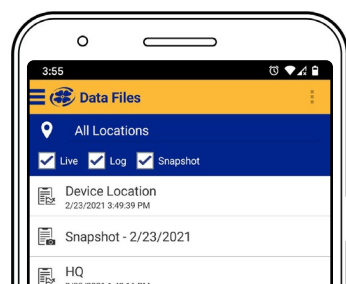

View the file from the Data Files screen.

Live Readings Mode

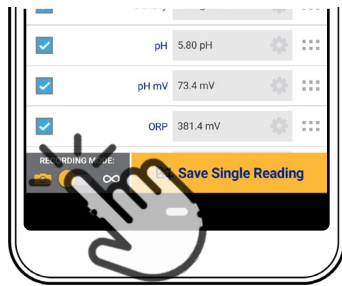

Tap the button on the bottom left to switch from snapshot mode to live readings mode.

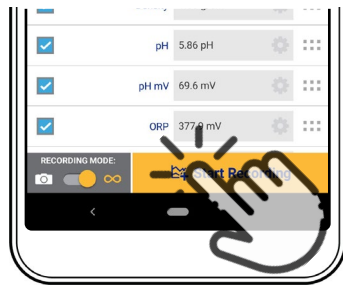

Tap **Start Recording**. The instrument takes a reading every two seconds.



Tap **Stop** to end the recording. VuSitu displays a summary of the live readings data.

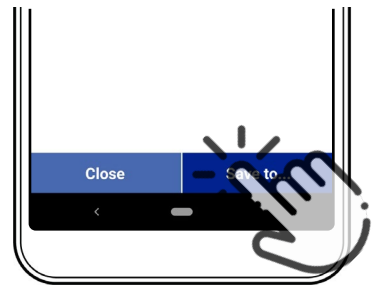

Tap **Save to** if you wish to share the Live Readings file via email or cloud storage.

VuSitu Data



You can transfer a data file from your mobile device to a PC via Bluetooth, email it to yourself or any valid email address, or upload it to Google Drive.

Sharing Data

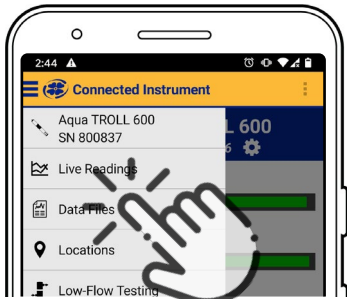

Select **Data Files** from the menu at the top left corner of the screen.

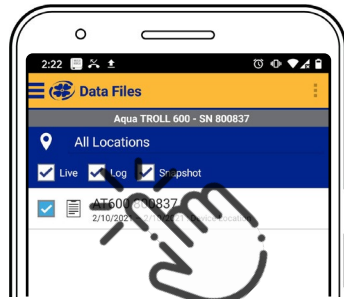

Tap and hold the name of the log you want to share.

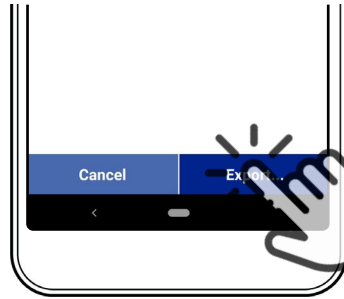

Select **Export**.

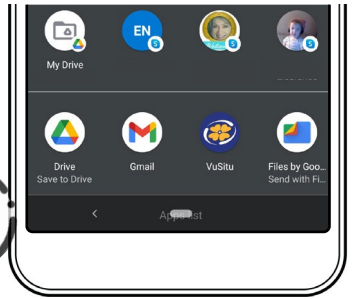

Choose email, cloud storage, or another sharing option.



To save data locally on your mobile device, export to a third-party file management app.

Viewing Data on a Mac or PC



You'll need to extract your files to view them. To do that on a Mac, double-click the Zip folder. On a PC, right-click on the folder and choose **Extract**. Then open your files in Excel.

Selecting with Long-press and Swipe

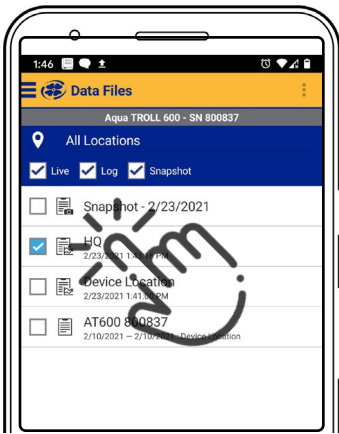

Press and hold any item in a list of files. You can now select multiple files.

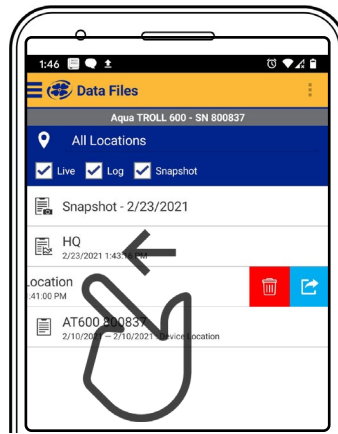

Press and swipe left to reveal the delete and share icons.

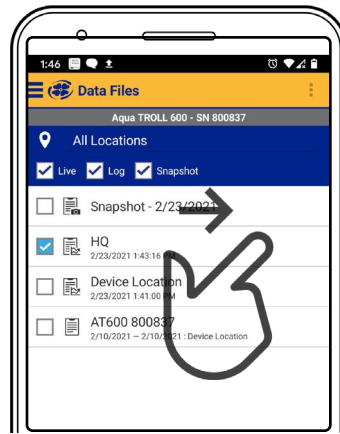

Press and swipe right to reveal the sharing icon.

VuSitu Locations

About VuSitu Locations

A VuSitu location represents the physical spot where an instrument collects data. You can create a VuSitu location for any monitoring site. If you don't create a location, your data defaults to "Device Location." Location names appear on the live readings screen, in snapshot files, and in log files.

How to Create a Location

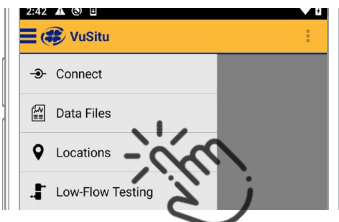

Select **Locations** from the main menu.

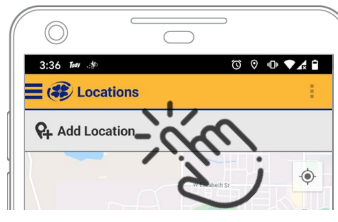

Tap **Add Location**.

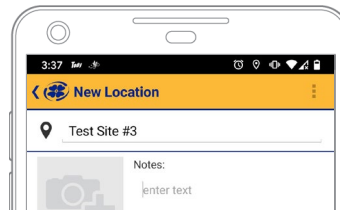

Enter a name for the location. You can also add notes.



If desired, tap the camera icon to take a photo of the new location.

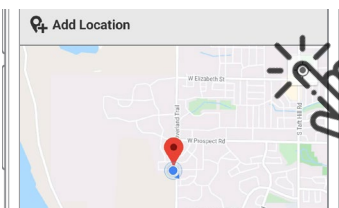

To home in on your mobile device's current location, tap the button on the top right.

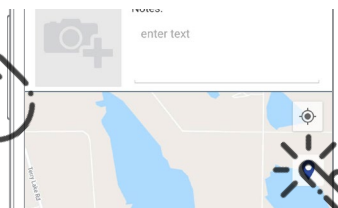

Tap the pin icon to establish the location on the map.



As an alternative, you can manually enter latitude and longitude values and tap **Apply**. Or, tap and hold a specific point on the map to drop a pin there.

How to Select a Location



Data is associated with the Location that is displayed on the Live readings screen. After you have created a Location, you must select it in order for your data to be associated with the Location.

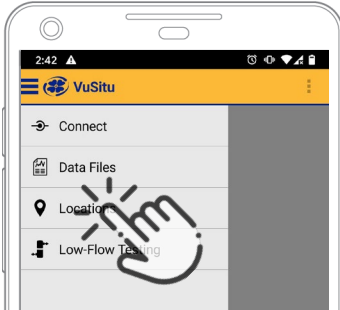

Select **Locations** from the app menu.

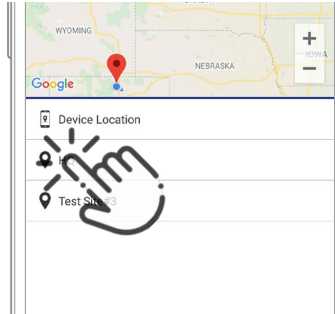

Tap a location to select it.

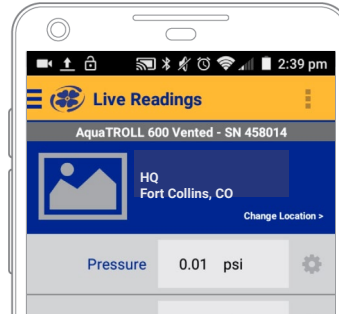

New live readings data will be associated with this location until you select another.

How to Edit or Delete a Location

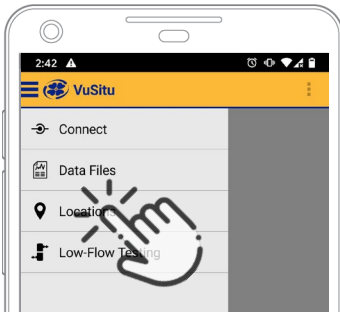

Select **Locations** from the app menu.

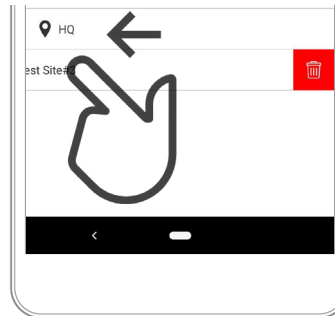

Tap the location you wish to delete and swipe left. Tap the trash icon.

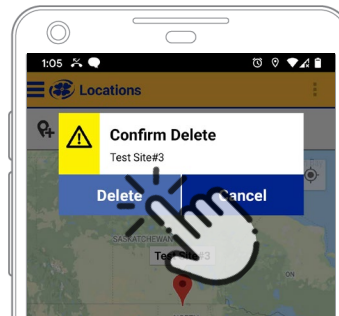

Confirm by tapping **Delete**.

Calibrating Sensors in VuSitu



Always wear appropriate personal protective equipment and use proper laboratory technique when calibrating the sensors and operating the instrument.

Calibrating the pH Sensor



Select Calibrations from the main menu.

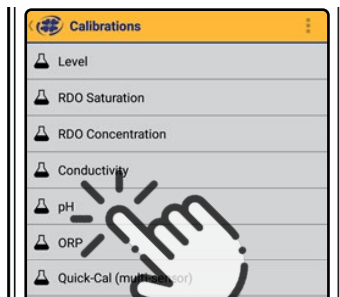

Choose the pH option.



Choose the number of calibration points to perform.



Pour pH buffer solution in the calibration cup until it reaches the fill line. Then insert the Aqua TROLL 400 into the calibration cup with the restrictor (the metal end) pointing down.

VuSitu will automatically detect the pH of your buffer solution. Allow several seconds for stabilization. When you see "Stabilized" in the green box at the bottom of the screen, click Accept.

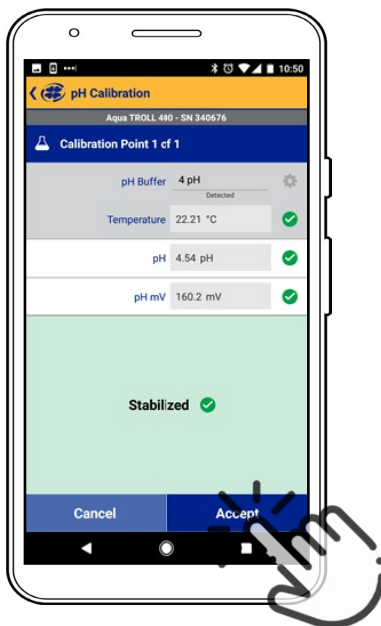

You can accept the calibration at the Nominal stage, or wait for it to fully stabilize.

Calibrate the Rugged Dissolved Oxygen Sensor (1-Point)

The optical Rugged Dissolved Oxygen sensor is very stable. The factory calibration should produce readings within 3% accuracy. If you require readings with greater accuracy we recommend that you perform a 1-point, 100% water-saturated air calibration as described below.

100% Water-saturated Air Calibration

1. From the main menu, select Calibration & Settings.
2. From the Calibrations menu select RDO Saturation.
3. For a 1-point calibration, select 100% Saturation.
4. Make sure the vented cap is installed on the calibration cup and a water-saturated sponge is placed in the bottom of the cup.
5. After the calibration is stable, select Accept.
6. The calibration values are applied to the sensor and appear on screen. You can view a full calibration report for all sensors, or select Done to return to the Calibration Menu.
7. Remove the sponge from the calibration cup.

Calibrate the Rugged Dissolved Oxygen Sensor (2-Point)

We recommend that you perform the 0 % oxygen calibration only if you intend to measure dissolved oxygen at a concentration of less than 4 mg/L.

100% Water-saturated Air Calibration

1. From the main menu, select Calibration & Settings.
2. From the Calibrations menu select RDO Saturation.
3. For a 2-point calibration, select 100% and 0% Saturation.
4. Make sure the vented cap is installed on the calibration cup and a water-saturated sponge is placed in the bottom of the cup.
5. After the calibration is stable, a prompt to prepare for the next calibration point appears.

0-point Calibration

1. Remove the sponge from the calibration cup.
2. Fill the calibration cup to the fill line with sodium sulfite. Place the instrument in the calibration cup.
3. Select Next.
4. After the calibration is stable, select Accept.
5. The calibration values are applied to the sensor and appear on screen. You can view a full calibration report for all sensors, or select Done to return to the Calibration Menu.
6. Rinse the sensors and restrictor with DI water.

Calibrating the Rugged Dissolved Oxygen Sensor Using Concentration

The preferred method of calibrating the RDO sensor is using the 1-point 100% Saturation calibration. However, you can also calibrate the sensor using a concentration method.

1. From the main menu, select Connected Instrument.
2. Select Calibrations.
3. Tap RDO Concentration.
4. Place the instrument in reference solution and tap Next.
5. Enter the value of the reference solution.
6. After the calibration is stable, select Accept.
7. The calibration values are applied to the sensor and appear on screen. You can view a full calibration report for all sensors, or select Done to return to the Calibration Menu.

RDO Salinity Setting

The Aqua TROLL 400 includes automatic salinity compensation. This feature is active by default. To change the compensation value, follow these steps:



Select Instrument Settings from the menu at the bottom of the screen.

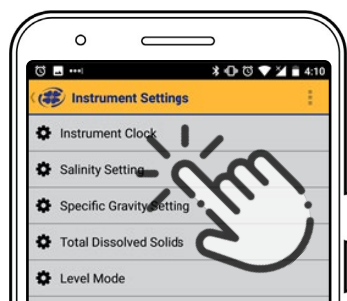

From the Instrument Settings menu, select Salinity Setting.

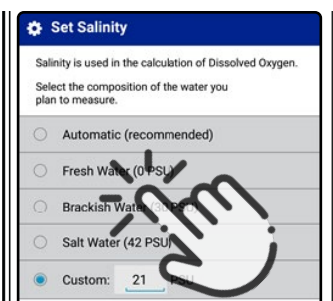

Enter your desired salinity compensation setting and press Save.

Communication Settings

Before you program the instrument to work with your PLC/SCADA system, you must set appropriate communication settings using a TROLL Com, AC/DC converter, and Win-Situ 5 Software. The software can also be used to calibrate sensors and to restore factory calibration and communication settings.

Connect the Instrument to the Computer

Using a direct-connect TROLL Com Communication Device, powered with an AC/DC power supply, you can connect the Aqua TROLL 400 to a computer running Win-Situ 5 Software version 5.6.22 or later.







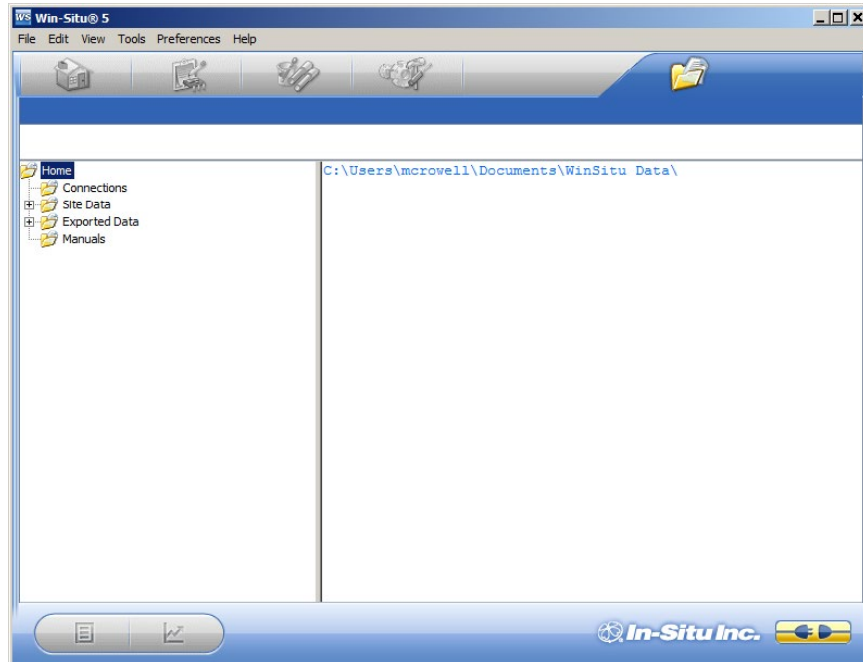

Connect the Instrument to Win-Situ 5 Software

Install Win-Situ 5 Software from www.in-situ.com. Make sure you select the check box that installs the USB drivers. Open Win-Situ 5 Software and click the Connect button to connect to the instrument.

Win-Situ Software

Data Tab



Screen Element	Definition
	The disconnected plug indicates the instrument is not communicating with the software. Click to establish communication with a connected instrument.
	The connected plug indicates the instrument is communicating with the software. Click to disconnect the software from the instrument.
	The Home tab displays real-time readings from the instrument. When connection to the instrument is first established, the software displays one reading of all available parameters in light gray. You must click the Play button at the bottom of the screen to view real-time readings.
	The Logging tab displays a list of logs stored in the connected instrument. When you click the Logging tab, it can take a moment for the software to retrieve information from the instrument. (Not applicable for the RDO PRO-X and the Aqua TROLL 400.)
	The Sensors tab lists the sensors in the connected instrument, along with their serial numbers and the dates of factory calibration and user calibration. Use the buttons in this tab to calibrate sensors that support user calibration and configure sensors that are supported by the instrument.
	The Device Setup tab allows access to instrument information and settings such as instrument name, serial number, firmware version, communication settings, diagnostics, and factory reset options.

Set Communication Outputs

The Device Setup Tab allows you to access communication settings, instrument information and status, factory reset, diagnostics, and alarm setup. The instrument can communicate via Modbus or SDI-12 protocols. However, the instrument can use only one of the protocols at a time.

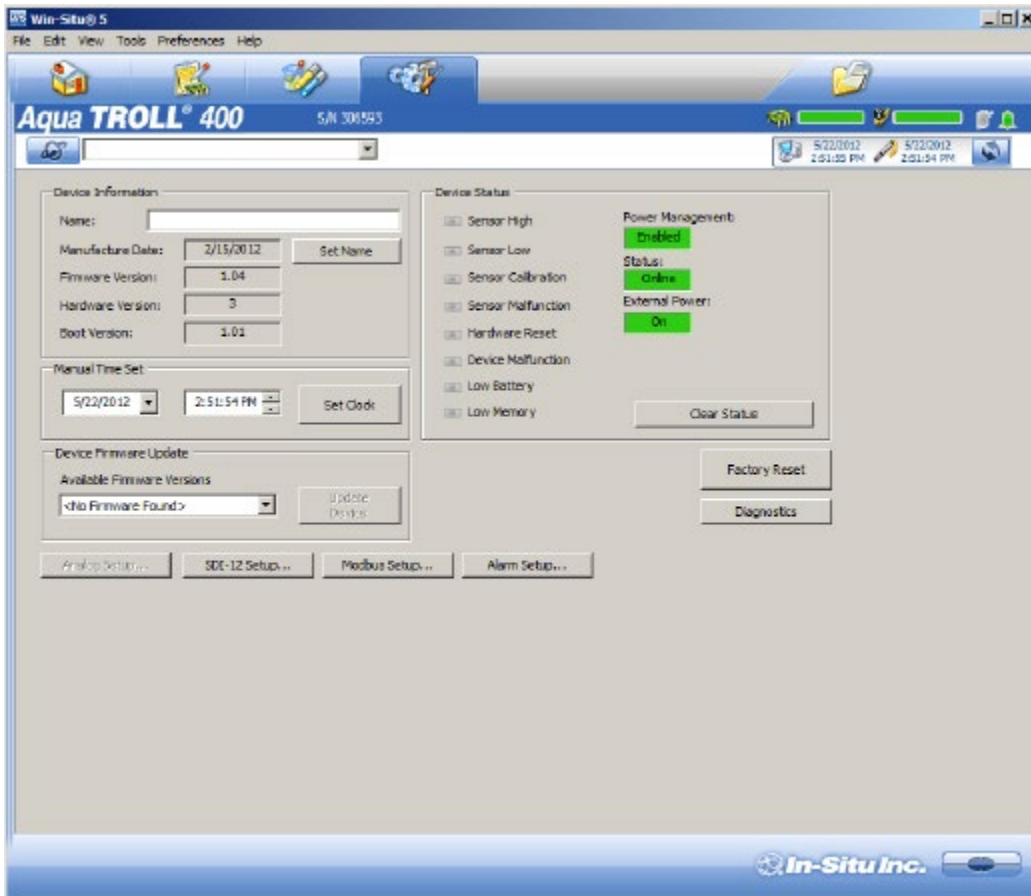

Modbus Setup

Click the Modbus setup button and assign instrument settings according to the requirements of your controller. For instrument Modbus registers, see the Modbus and SDI-12 Reference Guide.

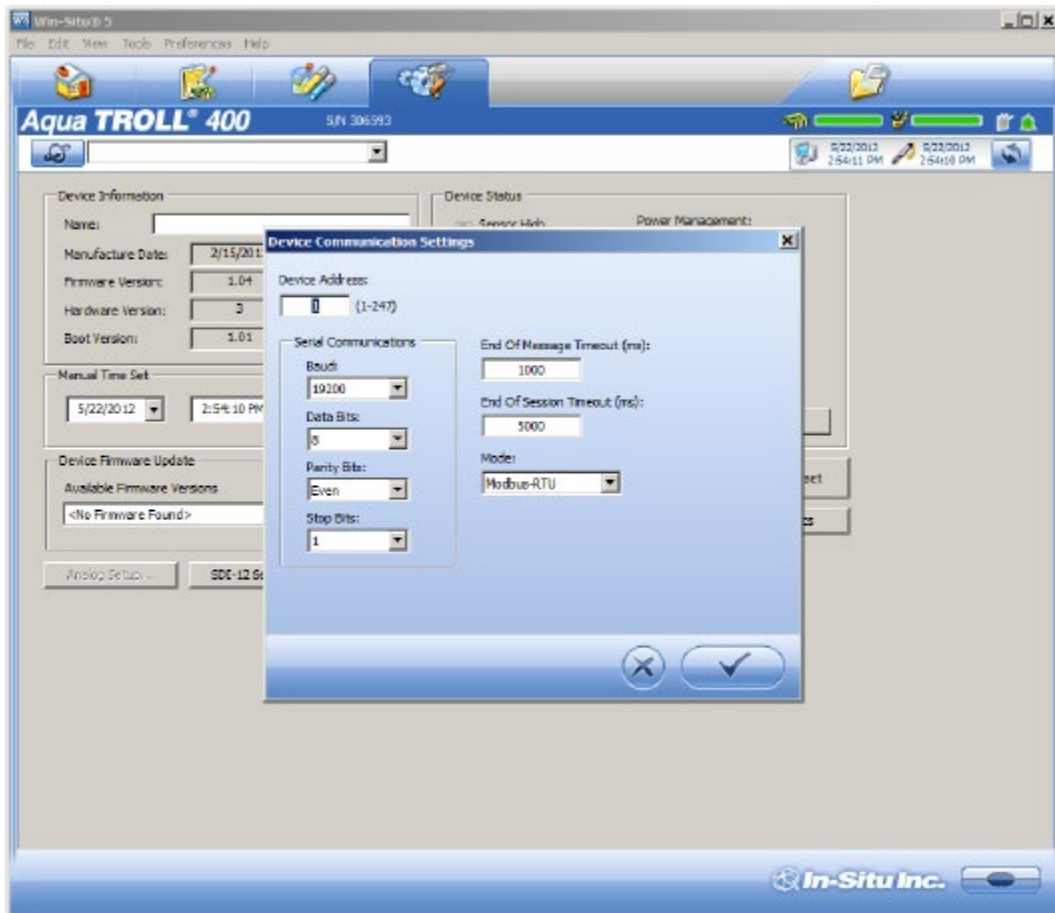

SDI-12 Setup



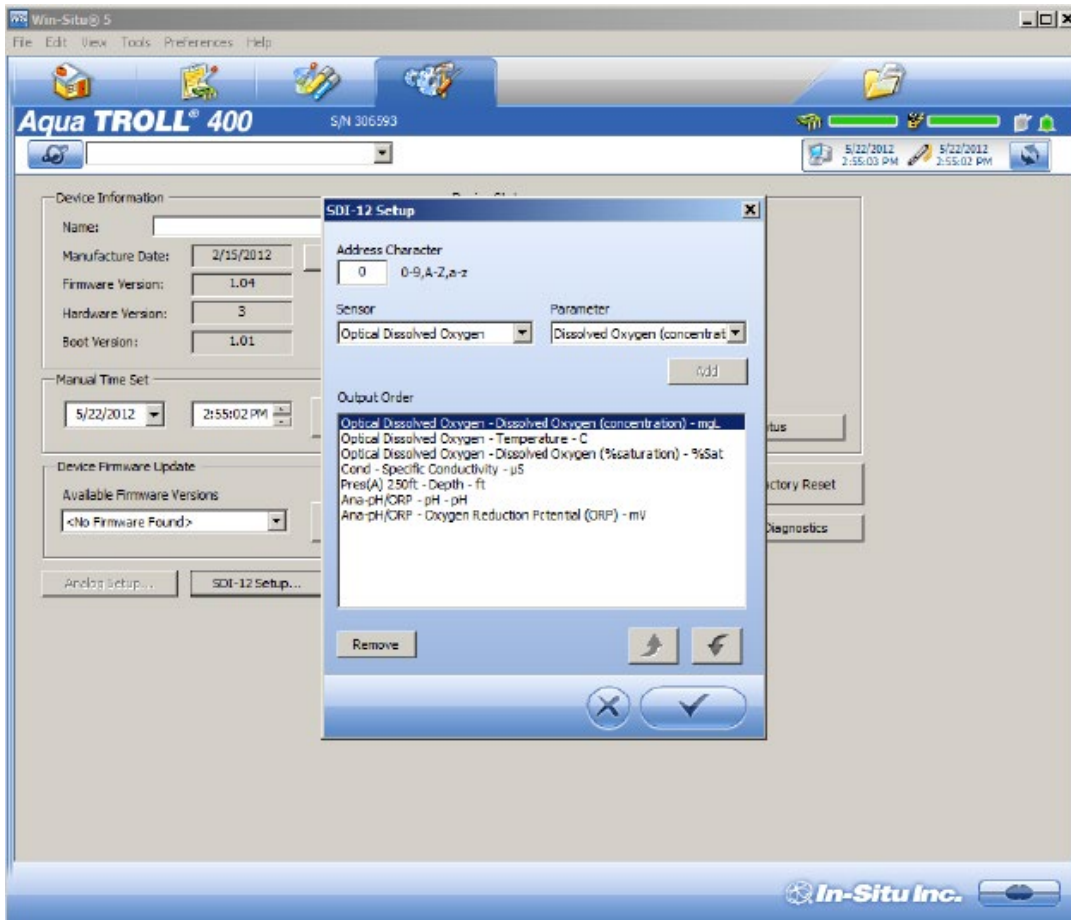

SDI-12 setup allows you to set the instrument address, select the parameters you intend to log, and select the order in which the parameters will appear in your SCADA system or datalogger file. See the Help menu in Win-Situ 5 Software for details. To view SDI-12 programming information, see the Modbus and SDI-12 Reference Guide.



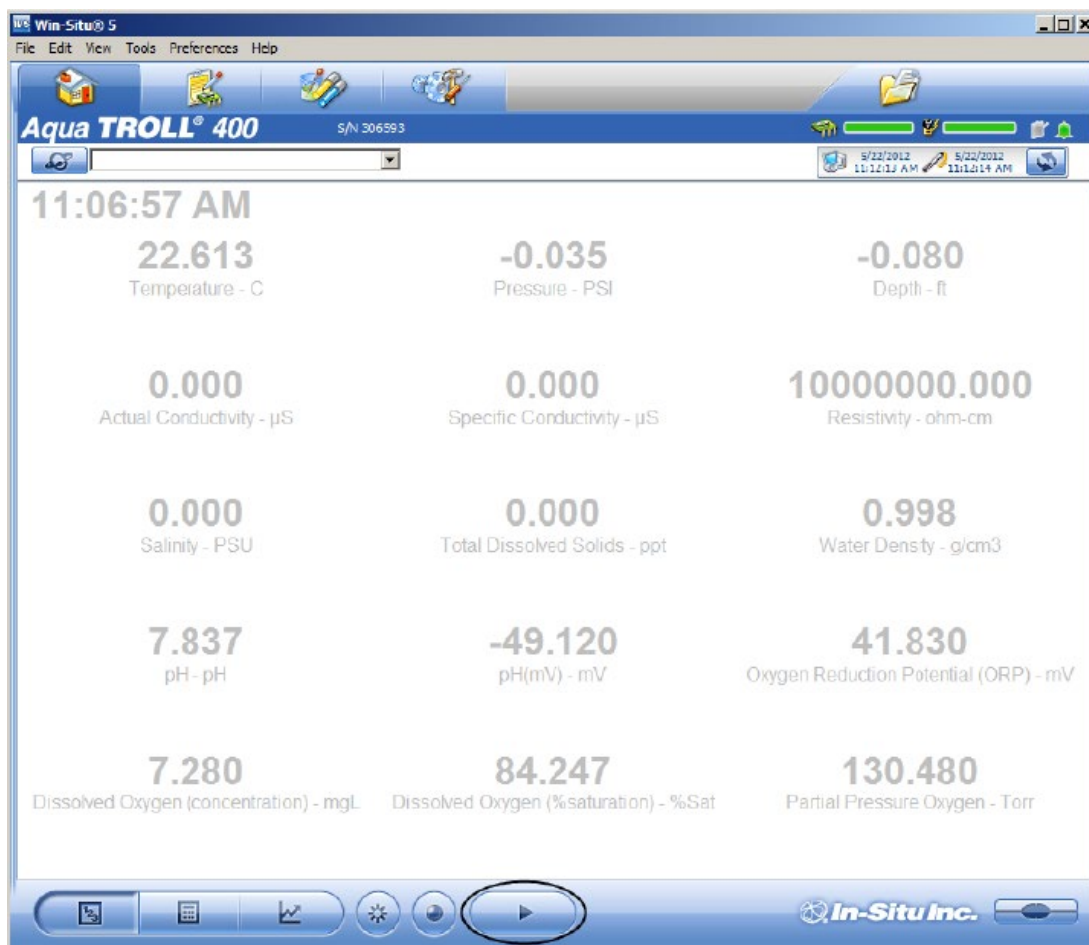







View and Record Data

The Home tab allows you to view data for the parameters that have been enabled. Gray values indicated that the instrument is not polling live data. To poll live data, click the Play button.



Screen Element	Definition
	The Sites button allows you to add, edit, or delete a site. (Not applicable for Aqua TROLL 400 and RDO PRO-X.)
	These icons allow you to view the memory and battery usage for an instrument that includes internal logging. (Not applicable for Aqua TROLL 400 and RDO PRO-X.)
	This icon allows you to view the logging status for an instrument that includes internal logging. (Not applicable for Aqua TROLL 400 and RDO PRO-X.)
	<p>The Alarm icon provides additional instrument status information.</p> <p>Green—No alarms or warnings Yellow—One or more warnings Red—One or more alarms</p> <p>Move the cursor over the alarm icon to view a description. Click the Device Setup tab for detailed information on the alarm or warning. (Not applicable for Aqua TROLL 400 and RDO PRO-X.)</p>

	<p>System Time is displayed on the left. Device Time is displayed on the right. Clocks are updated once every two seconds. When the Device Time is displayed in red, it differs from the current System Time, and should be synchronized.</p>
	<p>The Time Sync button is used to write the current PC time to the instrument. If you need to set the instrument clock to a time other than the system (PC) time, use the Set Clock button on the Device Setup tab.</p>
	<p>Meter View shows the last known parameter values, displayed with current units and time stamp. Readings are sized to occupy the entire screen. This is the default display in the Home tab. If the type is black, the readings are updating in real time.</p>
	<p>List View is a running list of the most recent records. New readings are continuously added to the top of the list and old readings scroll off the bottom.</p>
	<p>Graph View shows a real-time trend graph of the selected parameters.</p>
	<p>The Snapshot button allows you to take a snapshot of the data that currently appears on screen and save it to a file. Non-logging instruments can save data as CSV files but not as WSL data files.</p>
	<p>The Stop button allows you to continuously record live data and save it to a file. Non-logging instruments can save data as CSV files, but not as WSL data files.</p>
	<p>The Play button allows you to start and stop data polling.</p>

Calibrate and Set Up Sensors

The Sensors tab allows you to view the sensors that are available on the instrument. From this tab you can access calibration Wizards and sensor setup options. You can also view sensor serial numbers, factory calibration dates, and user calibration dates.

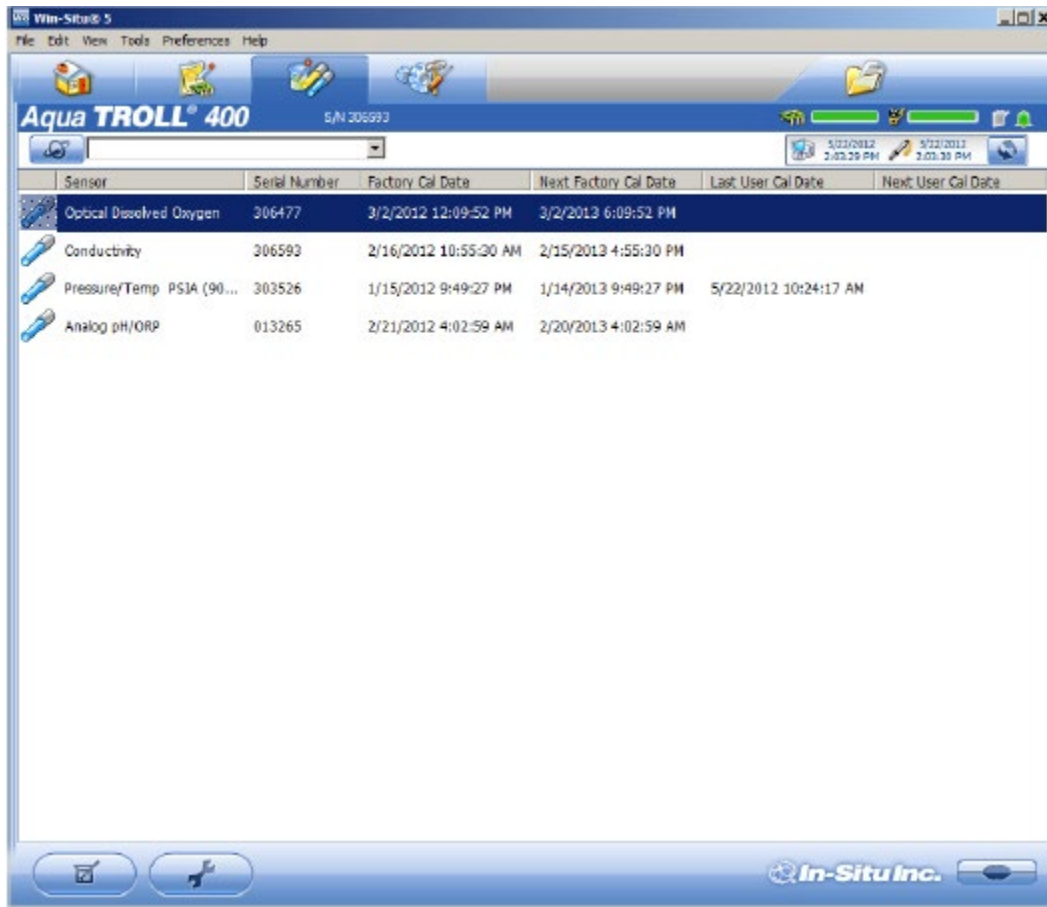

Screen Element

Definition



The Calibration button starts the Calibration Wizard for the selected sensor.



This button opens the setup options for the selected sensor. These options include selecting parameters, setting units, and setting sentinel values.

When you click on the sensor you want to calibrate or configure, the Calibration button and the Sensor Setup buttons become active.

Calibration Frequency Recommendations

In-Situ sensors are factory calibrated across the entire range of each sensor, and thus achieve a very high degree of accuracy and stability for extended periods of time without user calibration. In-Situ recommends inserting the instrument into a known calibration standard to check the accuracy of a sensor prior to performing any user calibration if you suspect drift, unless a user calibration is required by a standard operating procedure. Calibration requirements will vary by application and fouling conditions.

Sensor	Recommended User Calibration Frequency	Recommended Factory Calibration Frequency	Notes
Conductivity	3-6 months	12 months	K-cell value: 0.7 to 1.3
pH	4-6 weeks or as required by user protocol or site conditions	12 months	Single point: Theoretical mV ± 30 mV 2- or 3-point Slope: -66 to 50 mV/pH 2- or 3-point Offset: ± 30 mV at pH 7
ORP	4-6 weeks or as required by user protocol or site conditions	12 months	Offset: ± 30 mV
RDO	12 months or as required by user protocol or site conditions	12 months	2-point Slope: 0.7 to 1.3 2-point Offset: ± 0.3 mg/L

Factory Calibration

Factory calibration includes a thorough cleaning, full functionality check and sensor adjustments to all applicable sensors over the entire calibrated temperature range. We recommend a factory calibration every 12 months or when the unit appears to drift significantly.

Set Parameter Units and Sentinel Values

You can set sentinel values and set units for parameters by selecting a parameter and clicking the Setup Sensor button.

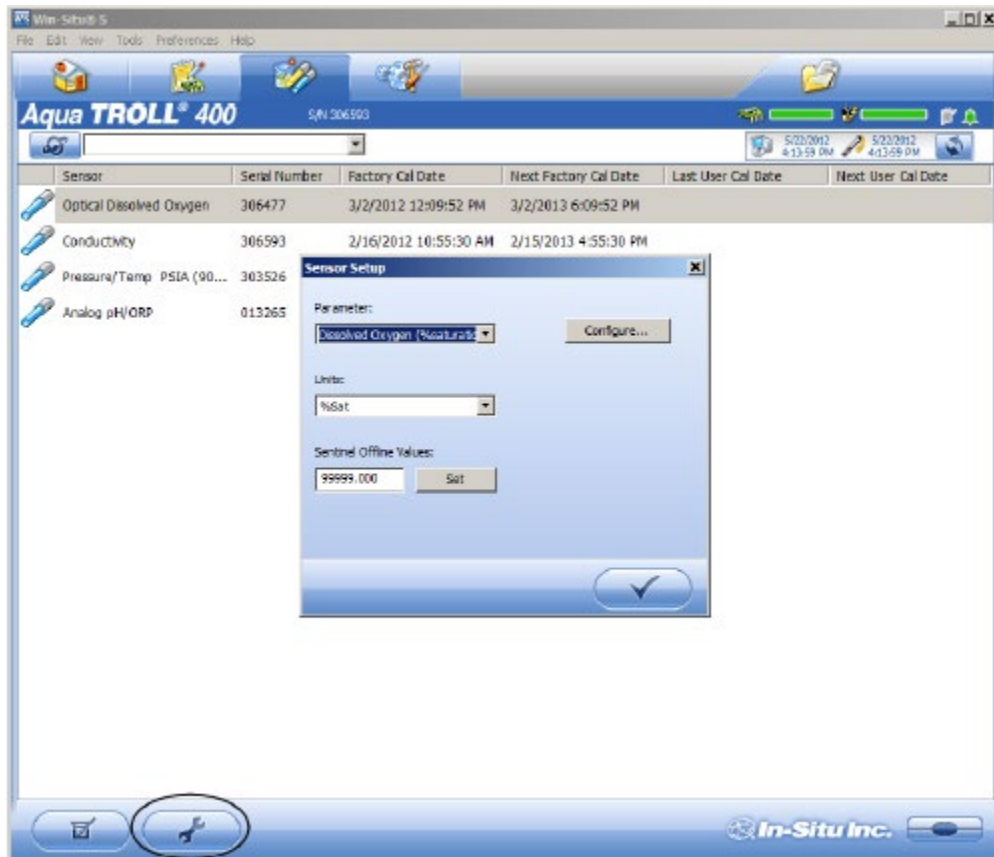

Screen Element	Purpose
Parameter	This menu lists the parameters that are available for the selected sensor.
Units	This drop-down list allows you to select units for the parameter you selected.
Sentinel Offline Value	This is a text field in which you can enter the value that you want to see in the data when a sensor is unable to communicate. After you have entered a value, click the Set button to save it.
Configure	This button becomes active when you select a parameter that includes additional configuration options. Click the Configure button to view the additional options.
Check mark	Clicking the Check mark saves the changes you have made in this screen.

RDO Sensor Calibration

The optical Rugged Dissolved Oxygen sensor is very stable. The factory calibration should produce readings within 3% accuracy. If you require readings with greater accuracy we recommend that you perform a 1-point, 100% water-saturated air calibration as described below.

Calibration 100% Oxygen Saturation

1. Place the calibration cap, with the vent hole, on the top of the calibration cup.

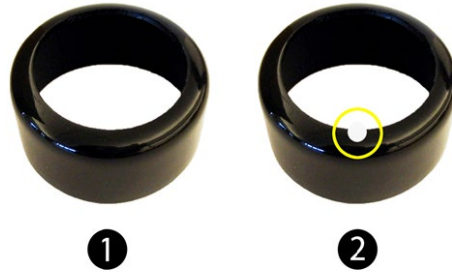

1	Storage cap
2	Calibration cap with vent hole

2. Place the sponge wafer in the bottom of the calibration cup and saturate the sponge wafer with approximately 10 mL clean water.
3. Gently dry the probe and sensing material with a paper towel. Ensure that the probe and the sensing surface are free of water and fouling.
4. Place the instrument into the calibration cup.



5. Wait 5 to 10 minutes for temperature stabilization prior to calibration.



Do not leave the instrument in the calibration cup for more than 30 minutes. This can cause condensation to form on the sensing material, providing false low readings after calibration.

6. In the software, select the Sensor Setup tab.
7. Select the RDO Dissolved Oxygen parameter.
8. Click Calibrate.
9. By default, 100% saturation is selected for the first point of the calibration. If you intend to perform a 2-point calibration, also select 0% saturation from the drop-down list. Otherwise, leave as "None."

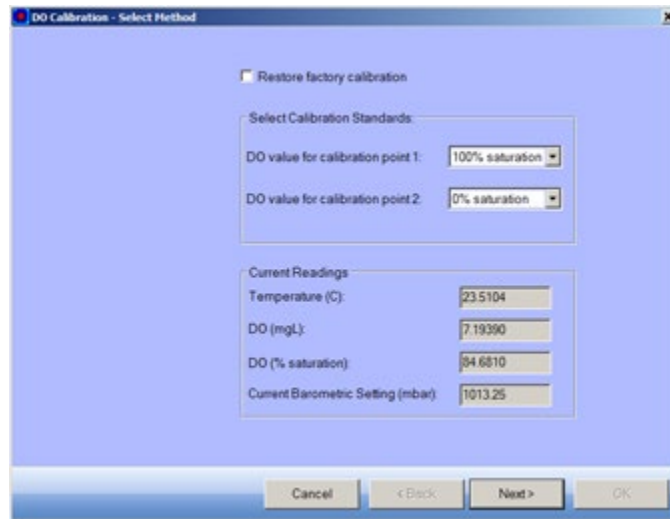

10. Click Next.
11. Enter the barometric pressure or elevation at which the instrument will be deployed.
12. Click Next.
13. Click OK to start the calibration.
14. When the screen indicates that the calibration has reached stability, click Accept to complete the calibration, or click Cancel to return to the previous calibration.

Calibrate 0% Oxygen Saturation

We recommend that you perform the 0 % oxygen calibration only if you intend to measure dissolved oxygen at a concentration of less than 4 mg/L.

1. If you selected to perform a 2-point calibration, you are prompted to set up the solution for the second point of the calibration.
2. Remove the wet sponge from the cup.
3. Fill the calibration cup to the fill line with approximately 130 mL of fresh sodium sulfite solution.
4. Gently place the instrument in the calibration cup, taking care to not force the solution out the top of the calibration cup.



5. Completely submerge the RDO Sensor into the solution.
6. Click OK, to start the calibration.
7. When the screen indicates that the calibration has reached stability, click Accept to complete the calibration, or click Cancel to return to the previous calibration.
8. You can save or print the calibration report.
9. Click OK to complete the calibration.
10. Once calibration is complete, remove the instrument from the calibration cup and rinse both thoroughly with clean water.

Conductivity Calibration

The conductivity sensor is calibrated with NIST-traceable standards at the factory, which provides a high degree of linearity across the entire operating range of 5 to 100,000 $\mu\text{S}/\text{cm}$. This sensor is capable of meeting its published specifications without requiring additional calibration by the user. Most commercially available standards can introduce a larger potential measurement error than the sensor's initial factory calibration. User calibration is recommended only if you must conform to a standard operating procedure or if the conductivity cell has undergone physical change (e.g., deposits on conductivity cell walls that cannot be removed or physical damage to the conductivity cell walls).

1. Fill the calibration cup to the fill line with approximately 130 mL of the desired calibration solution.
2. Place the instrument in the solution taking care to not force the solution out the top of the calibration cup.
3. In Win-Situ 5 Software, select the Conductivity sensor.

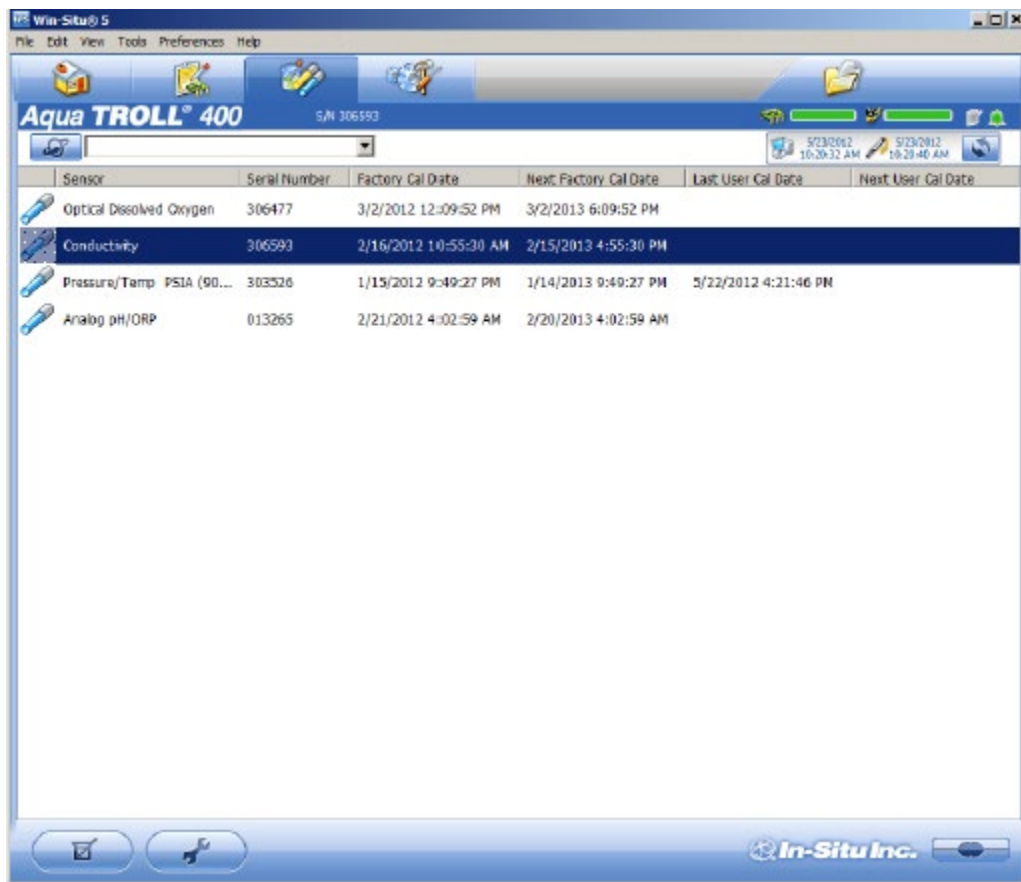

4. Click the Calibrate button in the left corner of the screen.
5. Select either 20° C or 25° C as the reference temperature, as indicated by the reference calibration solution.

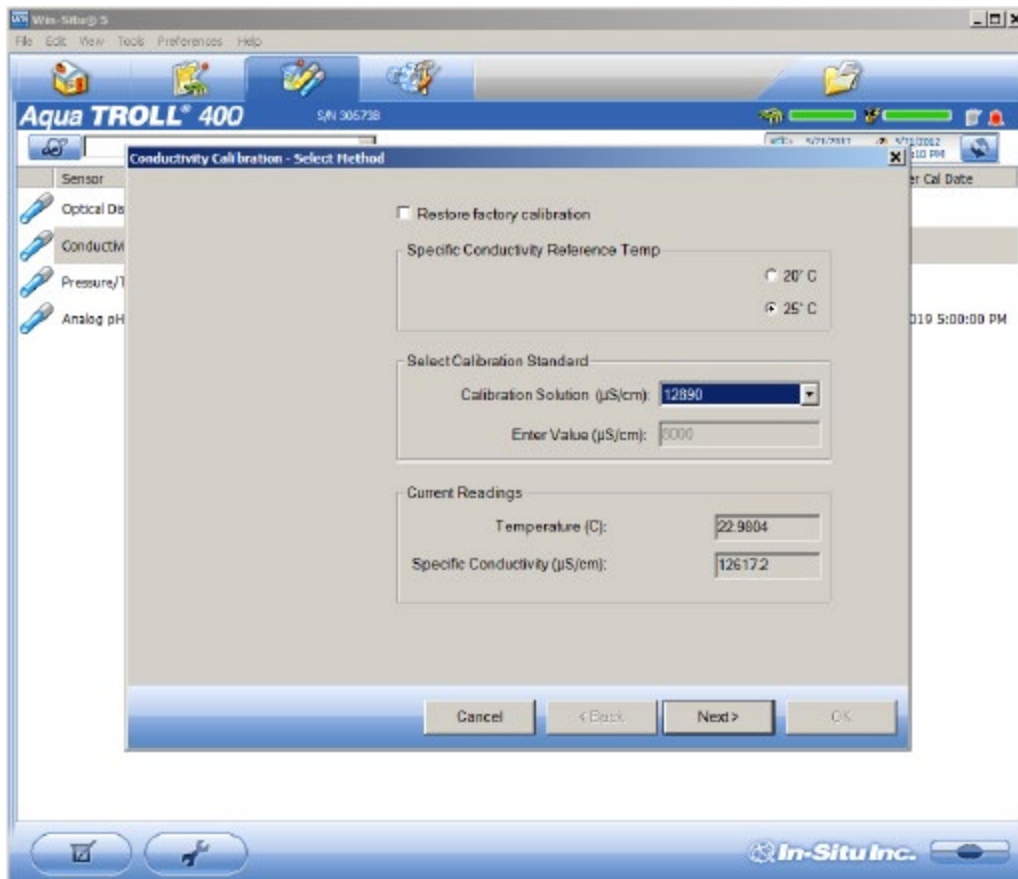

6. Select the appropriate calibration standard from the drop-down list. If you select "User Defined," enter the value of the solution.
7. Click Next.
8. Place the instrument into the calibration cup and allow time for the temperature to stabilize.
9. Gently tap the sides of the calibration cup against the palm of your hand to remove any bubbles in the conductivity cell. Visually inspect to ensure that all bubbles are removed.
10. Click OK to start the calibration.
11. When the screen indicates that the calibration has reached stability, click Accept to complete the calibration, or click Cancel to return to the previous calibration.
12. You can save or print the calibration report.
13. Click OK to complete the calibration.
14. Once calibration is complete, remove the instrument from the calibration cup and rinse both thoroughly with clean water.

Pressure/Level

The pressure sensor has been factory calibrated with NIST standards to a greater degree of accuracy than can be achieved in nearly any alternative setting. Therefore, user calibration is not necessary for the pressure sensor if it is a gauged sensor. If you encounter significant drift in pressure sensor readings, send the instrument to the factory for service. For best results, use the pressure sensor to measure Surface Elevation or Depth to Water.

Pressure/Level

We recommend calibrating the pH/ORP sensor after you perform cleaning and maintenance or every two to six weeks.

1. Fill the calibration cup to the fill line with approximately 130 mL of the desired pH or ORP calibration solution.
2. Place the calibration cap on the instrument slightly above the restrictor, and place the instrument in the solution taking care to not force the solution out the top of the calibration cup.
3. In Win-Situ 5 Software, select the pH/ORP sensor.

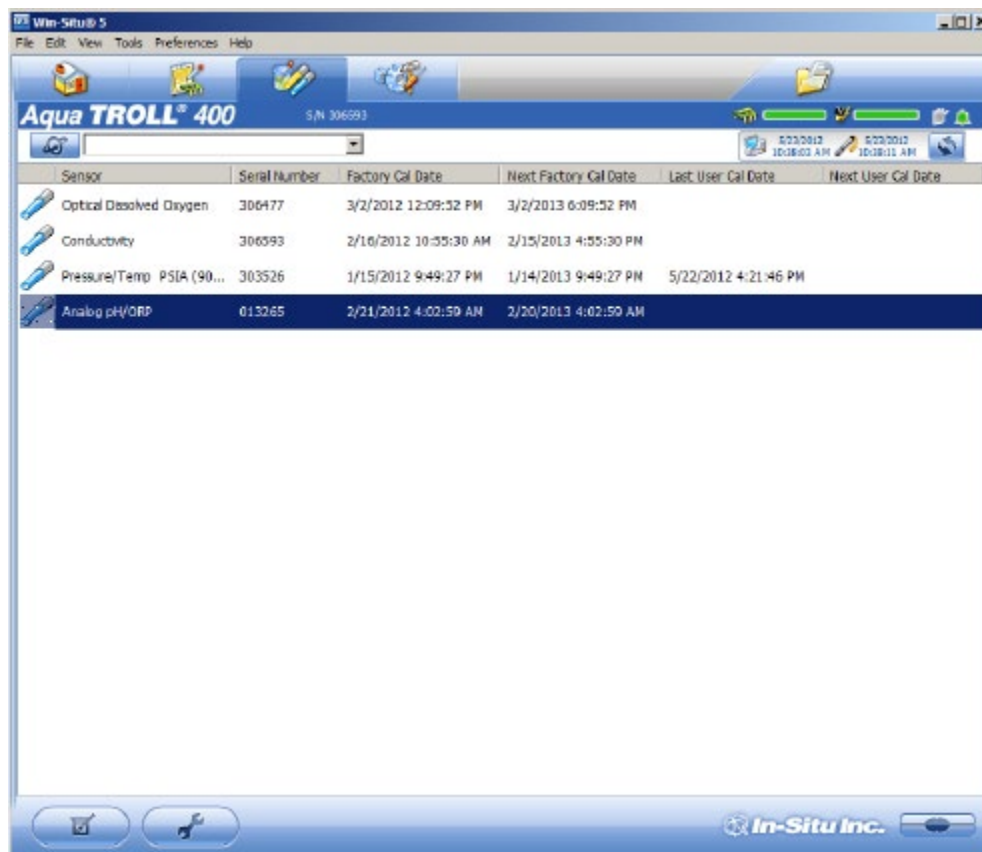

4. Click the Calibrate button in the left corner of the screen.

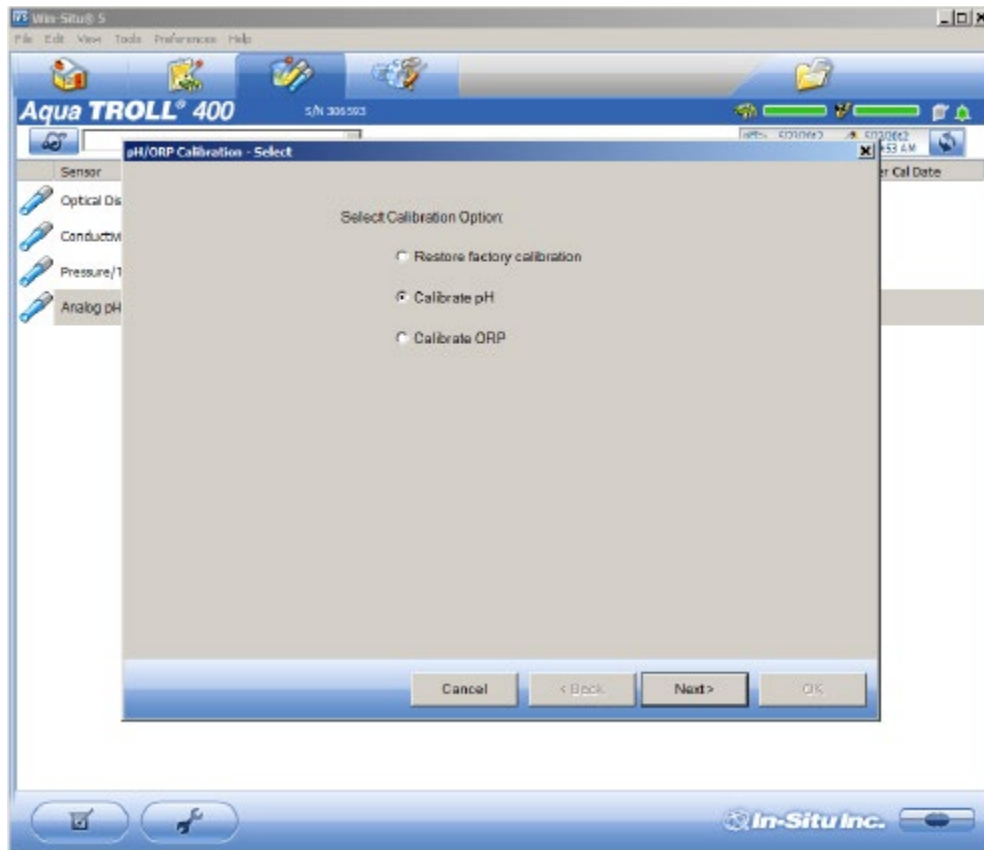

5. Select either Calibrate pH or Calibrate ORP.
6. Click Next.
7. Select a value for the first calibration point. If you intend to perform a 2-point or 3-point calibration, select the appropriate values as indicated on the label of the calibration standard.
8. Click Next.
9. Place the instrument into the calibration cup and allow time for the temperature to stabilize.
10. Click OK, to start the calibration.
11. When the screen indicates that the calibration has reached stability, click Accept to complete the calibration for that calibration point, or click Cancel to return to the previous calibration.
12. Follow the Wizard to continue through the remaining calibration points.
13. You can save or print the calibration report.
14. Click OK to complete the calibration.
15. Once calibration is complete, remove the instrument from the calibration cup and rinse both thoroughly with clean water.

Controller Requirements and Connections

The instrument can be connected to a controller or logger for communication via the following protocols.

- SDI-12
- RS485 Modbus
- RS232 Modbus (with converter)

Wiring Overview

Refer to the diagrams on the following pages. Trim and insulate unused wires. The shielded wire should be wired to a chassis ground or earth ground.

Stripped-and-Tinned Cable

Signal	Color
Ground/Return	Black
External Power	Red
No Connection	Brown
RS485 (-)	Green
RS485 (+)	Blue
SDI-12	White

Power Connections

The Aqua TROLL 400 requires an external 8 to 36 VDC power source. The red wire must be connected to the positive terminal of the power source. The black wire must be connected to the negative terminal of the power source, which is often referred to as the system ground or return.

SDI-12 Wiring Diagram

Cable length must not exceed 60.9 m (200 ft).

Signal	Color
Ground/Return	Black
External Power (9.6-16 VDC)	Red
SDI-12	White

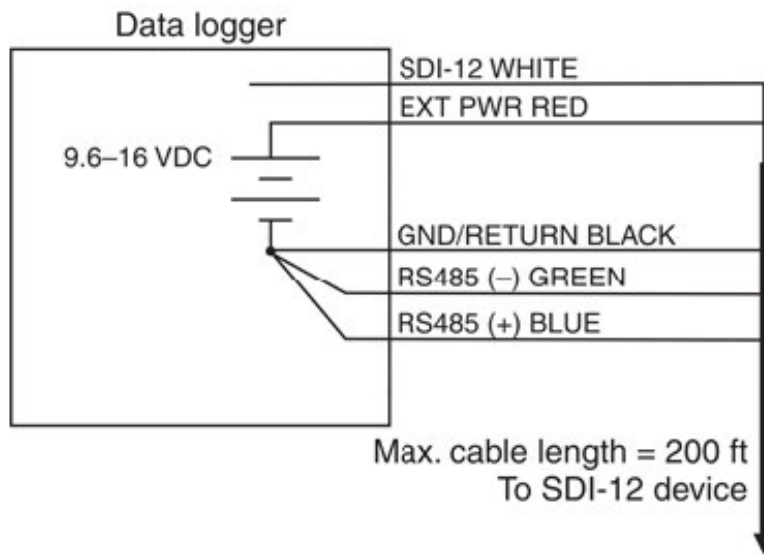

Configure SDI-12 Settings in VuSitu

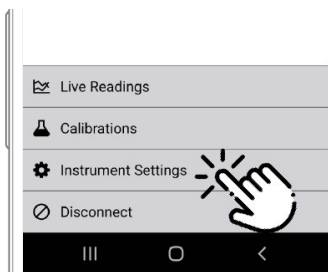

Connect to VuSitu and select **Instrument Settings**.

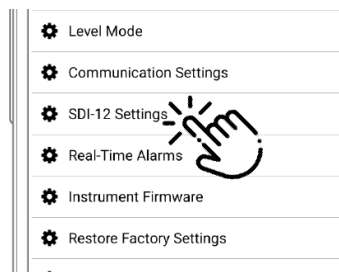

Choose **SDI-12 Settings**.

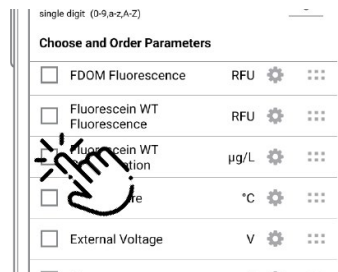

Use the checkboxes to select parameters to display.

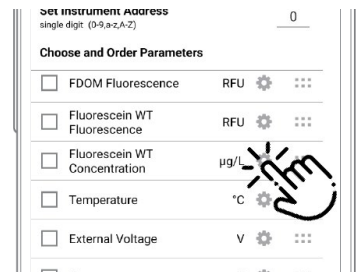

Tap the gear icon to adjust the units for each parameter.

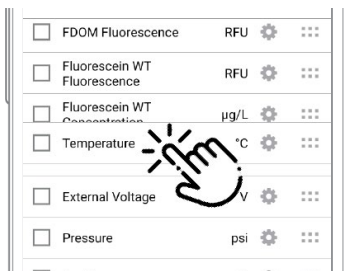

Drag and drop parameters to change the order.

Modbus Master RS485 Wiring Diagram

Cable length must not exceed 1,219 m (4,000 ft).

Signal	Color
Ground/Return	Black
External Power (12-36 VDC)	Red
RS485 (-)	Green
RS485 (+)	Blue

Modbus master with
RS485 built in

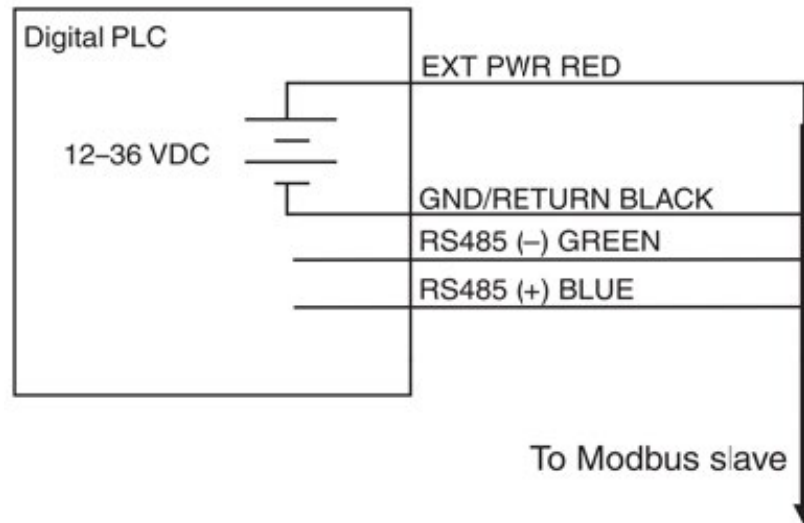

Modbus Master RS232 Wiring Diagram (Converter Required)

Cable length between Master and Slave must not exceed 1,219 m (4,000 ft). Cable length between Master and Converter must not exceed 6 m (20 ft).

Signal	Color
Ground/Return	Black
External Power (12-36 VDC, voltage limited by converter)	Red
RS485 (-)	Green
RS485 (+)	Blue

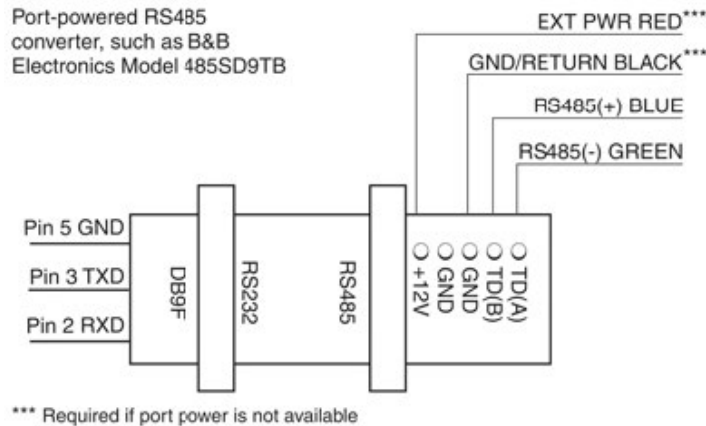
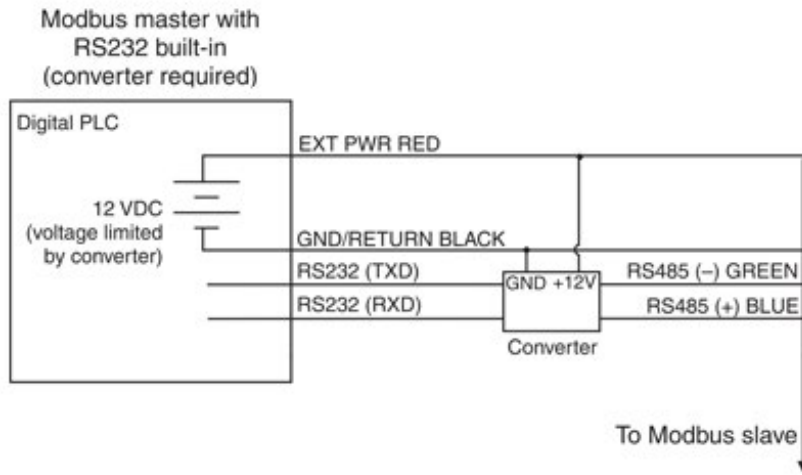

RS485 Network Guidelines

The instrument uses RS485 as its main digital communications link. RS485 is often used in an industrial setting as a small device network. There are some installation guidelines to follow when configuring an RS485 network with this instrument. See the Modbus and SDI-12 Reference Guide.

DB-9 Diagram

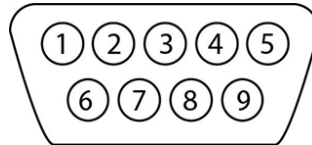

Pin	Signal Name	
1	Carrier Detector	DCD
2	Receive Data	RXD
3	Transmit Data	TXD
4	Data Terminal Ready	DTR
5	Signal Ground/Common	GND
6	Data Set Ready	DSR
7	Request to Send	RTS
8	Clear to Send	CTS
9	Ring Indicator	RI

Communication Overview

The instrument can be programmed to use either Modbus or SDI-12. Modbus and SDI-12 cannot be used at the same time. The protocol that is in use will block communication of the other.



See the Aqua TROLL 400 Modbus and SDI-12 Reference Guide for registers and programming information.

Prior to connecting the instrument to the controller, you must configure communication settings using Win-Situ software or the VuSitu mobile app and the communication device.

Device ID

Device ID for the AquaTROLL 400 is 18.

Data Quality IDs and the Sensor Health Table

Each sensor on the Aqua TROLL 400 instrument is associated with a corresponding Data Quality ID register. (See the Aqua TROLL 400 Modbus and SDI-12 Guide to set up registers.) When Data Quality ID registers are configured, they will return Data Quality ID numbers that can help you to troubleshoot issues with the system or verify that readings are normal. See the Sensor Health Table.

Sensor Health Table

Abbreviation	Data Quality ID	Text	Description
None	0	None	Normal Data Quality
UC	1	User Cal Expired	Parameter measured without errors using an expired user calibration.
FC	2	Factory Cal Expired	Parameter measured without errors using an expired factory calibration.
ERR	3	Unknown Error	Parameter measured with error, sentinel value supplied.
WU	4	Sensor Warm-up	Sensor is warming up, sentinel value supplied.
DIS	5	Sensor Warning	Parameter measured but does not meet normal quality criteria. The sensor has sustained moderate damage, or the recommended lifespan has been reached.
CAL	6	Sensor Calibrating	Sensor is calibrating, calibration value supplied.
OL	7	Sensor Missing	Sensor communication failed, sentinel value supplied. Make sure the sensor cap is installed and properly seated.

Care and Maintenance

Maintenance Schedule

For best results, send the instrument to the manufacturer for factory calibration every 12 to 18 months.

User-Serviceable Parts

The user-serviceable parts on the instrument include the O-rings, the pH/ORP sensor, and the RDO Sensor Cap.

O-rings

The instrument has several O-rings that can be maintained by the user in order to keep moisture from entering the instrument and damaging the electronics. Apply a very thin layer of vacuum grease to new O-rings upon installation. The O-rings are located in the following areas.

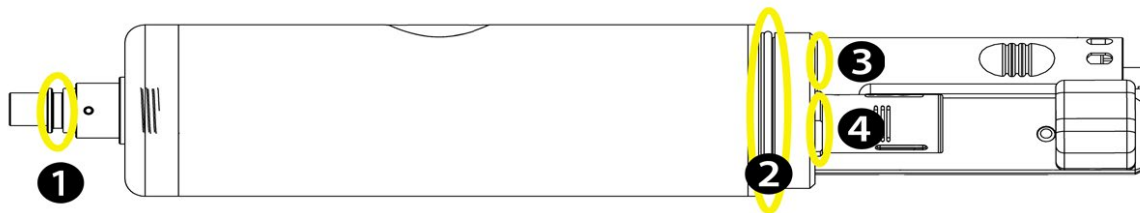

1	Connector
2	Instrument housing
3	pH sensor
4	RDO Sensor

RDO Sensor Cap Replacement

The RDO Sensor Cap has a 1-year typical life (15 months of total usage) after the sensor takes its first reading, or 36 months from the date of manufacture. Follow the instructions included in the RDO Sensor Cap Replacement Kit. Replacement caps are available from In-Situ Inc. or your authorized In-Situ distributor.

pH/ORP Sensor Replacement

To replace the pH/ORP sensor or to refill the reference junction, follow the instructions in the pH/ORP Sensor Instruction Sheet that is included with the replacement sensor.

Instrument Storage

To store the probe for a week or less, place the probe in the calibration cup with at least 10 mL of clean water to maintain a moist storage environment. To store the probe for more than a week, perform the following procedure.

1. Remove the pH/ORP sensor and place the orange pH port plug into the empty pH/ORP port to prevent any humidity from entering the probe.
2. Locate the sensor storage bottle in which the pH sensor was originally shipped.
3. Open the bottle and remove the O-ring.
4. Add enough pH storage solution or pH 4 solution to cover the sensor bulb (about 10 mL).

5. Slide the O-ring onto the sensor, and then slide the bottle cap over the sensor as shown.



6. Place the sensor tip in the buffer and tighten the cap to prevent the glass bulb from drying.

Cleaning the pH/ORP Sensor

Begin with the gentlest cleaning method and continue to the other methods only if necessary. Do not directly touch or wipe the glass bulb.

To clean the pH sensor, gently rinse with cold water. If further cleaning is required, consider the nature of the debris to determine the appropriate method.

Remove Crystalline Deposits

1. Clean the sensor with warm water and mild soap.
2. Soak the sensor in 5% HCl solution for 10 to 30 minutes.
3. If deposits persist, alternate soaking in 5% HCl and 5% NaOH solutions.

Remove Oily or Greasy Residue

1. Clean the sensor with warm water and mild soap.
2. Methanol or isopropyl alcohol may be used for short soaking periods, up to 1 hour.
3. Do not soak the sensor in strong solvents, such as chlorinated solvents, ethers, or ketones, including acetone.

Remove Protein-Like Material or Slimy Film

1. Clean the sensor with warm water and mild soap.
2. Soak the sensor in 0.1M HCl solution for 10 minutes and then rinse with deionized water.



After performing any of these cleaning methods, rinse the sensor with water and then soak overnight in pH 4 buffer.

Cleaning the RDO Sensor

Clean the Sensor Cap

1. Leave the cap on the sensor.
2. Rinse the sensor with clean water from a squirt bottle or spray bottle.
3. Gently wipe with a soft cloth or brush if biofouling is present.

4. If extensive fouling or mineral build-up is present, soak the RDO Cap end (while the cap is still installed on the sensor) in commercially available household vinegar for 15 minutes, then soak in deionized water for 15 minutes.



Vinegar is safe for all of the sensors on the probe including the RDO Sensor if the sensor cap is on.

5. Do not use organic solvents because they will damage the sensing material. Do not remove the cap from the sensor prior to wiping.
6. After cleaning the sensor cap, perform a 2-point calibration.

Clean the Optical Window

1. Perform this task only once per year when you replace the sensor cap.
2. Pull to remove the sensor cap.
3. Gently wipe the optical window with the supplied lens wipe.



Do not wet the interior lens area with water or any solution.

Cleaning the Conductivity Sensor

1. Before you begin, ensure that the RDO Cap and any removable sensors are in place. Rinse the conductivity sensor under running water to remove loose material.
2. Follow Cleaning Procedure 1. If debris is still present, progress to the next cleaning procedure. If the debris is removed, skip to the last step.

Cleaning Procedure 1

Avoid damaging the plastic material of the conductivity cell. Gently scrub the conductivity cell with a soft swab and mild soap such as a dilute solution of dish detergent. The probe is shipped with polyurethane foam swabs for this purpose. You can also achieve good results using a gentle back-and-forth motion with a thin cotton pipe cleaner. If debris is still present, continue to Cleaning Procedure 2. If the sensor is clean, skip to the last step.

Cleaning Procedure 2

Avoid damaging the plastic material of the conductivity cell. Gently scrub the conductivity cell with a foam swab and an aggressive soap such as Alconox cleaner. If debris is still present, continue to Cleaning Procedure 3. If the sensor is clean, skip to the last step.

Cleaning Procedure 3

Soak the sensor with dilute acetic acid (10:1 solution) or commercially available household vinegar to pre-soften calcium deposits. Follow this with Cleaning Procedure 1 or Cleaning Procedure 2, depending on the degree of residual contamination. The probe can soak for any length of time in household vinegar. If debris is still present, continue to Cleaning Procedure 4. If the sensor is clean, skip to the last step.

Cleaning Procedure 4

Typically apply dilute phosphoric acid (< 27 %) or the consumer product LIME-A-WAY with a soft swab to remove iron or calcium deposits that remain after using Process 3. Do not allow the cleaner to be in contact with the sensor for more than 10 minutes. Rinse well with clean water and continue to the last step. Check the sensor calibration before redeployment. Recalibrate the sensor when necessary.

Declaration of Conformity



Innovations in **Water Monitoring**

CE Declaration of Conformity

Manufacturer: In-Situ, Inc.
221 East Lincoln Avenue, Fort Collins, CO 80524, USA

Declares that the following product:

Product name: **Aqua TROLL 400**
Model: **Aqua TROLL 400**
Part Number: 0088300
Product Description: Multiparameter sonde for measuring water quality
Model Variants: None

is in compliance with the following Directive

- 2014/30/EU EMC Directive
- Restriction of the use of certain hazardous substances in electrical and electronic equipment (RoHS) Directive, 2011/65/EU and Commission Delegated Directive, (EU) 2015/863

and meets or exceeds the following international requirements and compliance standards:

EMC Standards:

EN 61326-1:2021

RoHS Standard:

EN 63000:2018

The CE mark is affixed accordingly.

David A. Bossie
Regulatory Compliance Manager
In-Situ, Inc.
July 13, 2022



WWW.IN-SITU.COM

221 East Lincoln Avenue, Fort Collins, CO 80524 USA

Toll Free: 800.446.7488 Tel: 970.498.1500 Fax: 970.498.1598

Copyright © 2015 In-Situ Inc. This document is confidential and is the property of In-Situ Inc. Do not distribute without approval.



UKCA Declaration of Conformity

Manufacturer: In-Situ, Inc.
221 East Lincoln Avenue, Fort Collins, CO 80524, USA

We declare that the performance of the following product:

Product name: Aqua TROLL 400
Model: Aqua TROLL 400
Part Number: 0088300
Product Description: Multiparameter sonde for measuring water quality.
Model Variants: None

is in compliance with the following Regulations:

- EMC Regulation 2016
- Restriction of the use of certain hazardous substances in electrical and electronic equipment (RoHS) Regulation (S.I. 2012:3032)

and meets or exceeds the following British requirements and compliance standards:

- **EMC:** BS 61326-1:2021
- **RoHS:** BS 63000:2018

The UKCA mark is affixed accordingly.

David A. Bossie
Regulatory Compliance Manager
In-Situ, Inc.
July 13, 2022

